

**Milling, plotting, engraving,
drilling, grinding, dispensing,
cutting and much more besides
with...**

WinPC-NC Economy

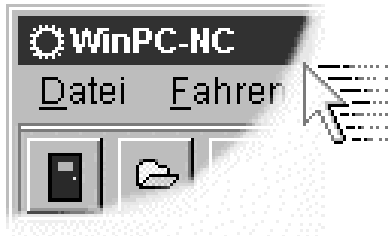

**...the software that turns your
standard PC into a universal
stepper motor NC unit**

**Version 2.00
July 2006**

Lawful purchase of the diskette and the manual conveys permission for one person to utilise the **WinPC-NC** control program. Copying the diskette and the manual or changing any of the individual files or elements of the manual are forbidden.

Furthermore any unauthorized transmission of the program or extracts of it will be legally prosecuted by all available means.

The authors reserve all rights to the programs and to the manual, in particular the copyright.

This control program has undergone extremely thorough testing. Nevertheless, it is impossible to give a guarantee for completely fault-free operation. Furthermore, no responsibility can be accepted for damage caused as a result of using our program.

Despite the most strenuous efforts, it is never possible to completely eliminate all faults. Consequently, we would be grateful to receive feedback from users.

Please note that support assistance and reduced updates are only available for registered customers. In order to be registered please send us a mail indicating version number and serial number (either noted on the CD or visible in the program window) as well as your complete address.

Please register your licence !!!!

Burkhard Lewetz
Hardware-Software
Brückenstrasse 7
D-88074 Meckenbeuren
eMail info@lewetz.de
Homepage www.lewetz.de

July 2006

MS-Windows is a registered trademark of the Microsoft Corporation.
AutoSketch, AutoCAD, AutoSketch for Windows are registered trademarks of Autodesk AG.
IBM is a registered trademark of the International Business Machines Corporation.
CorelDRAW is a registered trademark of the Corel Corporation.
Designer is a registered trademark of Micrografx,
Borland C++Builder is a registered trademark of Borland International, INC.
Other products mentioned by name are trademarks or registered trademarks of their corresponding companies.

2.000

Table of contents

The structure of this manual.....	5
Definitions.....	5
Use of typography.....	6
Various versions of WinPC-NC	7
1. What can WinPC-NC do ?	8
2. First steps.....	12
2.1. Requirements to the PC hardware.....	12
2.2. Possible restrictions during realtime operation.....	12
2.3. Installation.....	13
2.4. Launching the program.....	14
2.5. First steps and test moves.....	16
2.6. Exiting WinPC-NC	18
3. Operating WinPC-NC	18
3.1. Graphical display of the NC file.....	18
3.2. Drop-down menus and function keys	22
3.3. The individual menus.....	22
3.3.1. FILE menu	22
OPEN	23
OPEN WITHOUT PARAMETERS	23
EDIT.....	23
EXIT	24
3.3.2. MOVE menu.....	24
START	24
JOG	26
JOYSTICK JOG	28
REFERENCE MOVE.....	29
SELECT TOOL	29
3.3.3. PARAMETERS menu.....	31
SAVE	31
SAVE AS	32
LOAD	32
3.3.4. SPECIAL FUNCTIONS menu	32
SIGNAL TEST.....	33
MOTOR TEST	34
STATUS INFORMATION.....	35
JOYSTICK CALIBRATION.....	35
CHECK POSITION	36
TEACHIN.....	37
3.3.5. HELP menu.....	38
TOPICS.....	38
DISCLAIMER.....	39
ABOUT WinPC-NC	39

4. Parameter settings.....	40
4.1. Tool management.....	40
4.2. Speeds.....	46
4.3. Coordinates.....	49
4.4. Data format and associated parameters.....	57
4.5. Miscellaneous parameters.....	61
4.6. Ports.....	67
4.7. Signals and dwell times.....	68
4.8. Machine parameters	70
4.9. Macros.....	79
5. Initial start-up with the machine.....	82
5.1. Connecting the machine.....	82
5.1.1. Pin assignment of clock/direction version.....	83
5.1.2. Pinning of SMC version.....	84
5.2. Determination of axis resolution.....	85
5.3. Definiton of LPT port.....	86
5.4. Determination of move direction	87
5.5. Adjustment of reference switches.....	89
5.6. Sequence and direction of reference move.....	90
5.7. Control of adjustments.....	90
5.8. Additional steps.....	91
6. Signal wizzard.....	92
6.1. Using input and output signals.....	92
6.2. Assignment of inputs.....	93
6.3. Assignment of output liness.....	95
6.4. Input signals available.....	96
6.5. Output signals available.....	97
7. Additional information.....	98
7.1. Interpreters.....	98
7.1.1. HPGL.....	98
7.1.2. MultiCAM.....	100
7.1.3. Drilling.....	100
7.1.4. G code or DIN/ISO.....	101
7.1.5. ISEL NCP.....	104
7.1.6. Postscript.....	105
7.2. Error messages.....	105
7.3. Special versions of <i>WinPC-NC</i>	108

The structure of this manual ...

This manual provides you with all the information needed for using *WinPC-NC*. It is divided into individual chapters, the contents of which are summarised below:

- Chapter 1:** Brief explanation about *WinPC-NC*, the possibilities for using it and the hardware requirements.
- Chapter 2:** Initial start-up procedure, description of how to install the program and how to adjust the initial specific parameters.
- Chapter 3:** More detailed descriptions of how to operate the program and the individual functions of *WinPC-NC*.
- Chapter 4:** Explanation of all parameters and the setting options.
- Chapter 5:** Initial start-up procedure step by step
- Chapter 6:** Information concerning definitions and adjustments of input/output signals
- Chapter 7:** Further technical information about the program, about the implemented NC format interpreters, error messages and special versions.

Definitions

Some of the terms used in this manual may require an explanation:

- Job file**
or
NC file A file with NC data which is read and processed by *WinPC-NC*. Depending on the application, the file may contain milling, plotting, drilling data or other types of data.
- Job process** The process of reading and processing a job file and the resultant actuation of the machine.
- Command** An individual instruction in the job file which gives rise to actions by the machine or in *WinPC-NC*.
- Button** Mouse clickable field to activate a certain function
- Checkbox** Box for activating or deactivation a certain parameter or function, e. g. signals. An activated checkbox is marked with a cross.

Descriptions of the machine and the movement directions of the individual axes are made with reference to the following mechanical layout of a flat-bed machine. The assignment of axes depend on your personal position and your viewport to the machine.

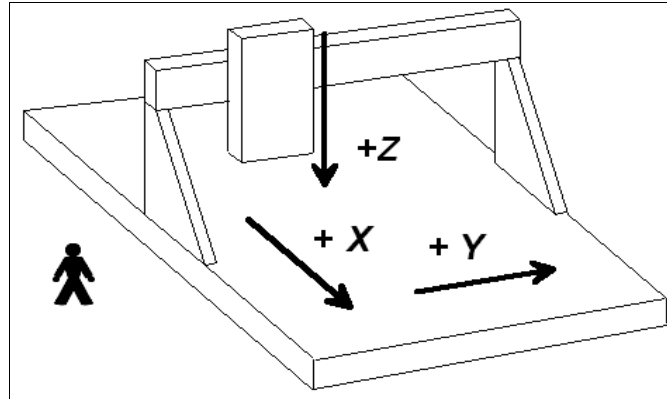

Schematic layout of a flat-bed machine with your position aside

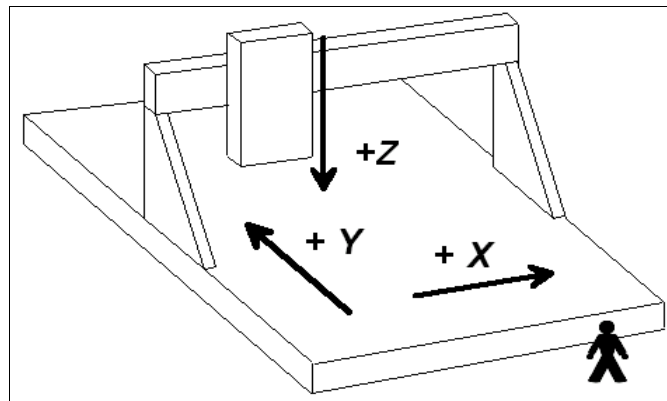

Schematic layout of a flat-bed machine with your position in front of

Use of typography

Keyboard entries	Normal script enclosed in a box, e.g. (ENTER)
Cursor keys	Normal script enclosed in a box with english definitions, e.g. (UP), (LEFT), (PGDN)
Menu functions	Capital letters with menu path, e.g. <i>FILE-DISPLAY</i>
Messages	Italic script, e.g. <i>'Perform reference movement? Y/N'</i>
Function names	Capital letters, e.g. <i>SIGNAL TEST</i>

Different versions of *WinPC-NC*

The controlling program *WinPC-NC* is available in three different versions.

Our lowcost program *WinPC-NC Light* offers all necessary functions for beginners, e.g. engraving, milling, drilling and PCB drilling or manufacturing modelling parts.

WinPC-NC Economy is equipped with additional functions and offers with up to four axes a lot of special functions and provides support of extraordinary mechanical components.

This program disposes of much more format interpreters as the version for beginners.

WinPC-NC Light and *Economy* are also available for SMC stepper cards, i. e. motors are not controlled by clocking/direction signals but by SMC signals.

WinPC-NC Professional is considered as industrial version and runs only in combination with our external axes controller CPU and is therefore most qualified for all true realtime tasks. The program is fairly independent of windows speed and provides besides utmost stability and reliability additional professional technology functions.

1. What can WinPC-NC do ?

Universal program

WinPC-NC is a software program which takes any standard personal computer and turns it into a universal NC control system for up to 4 axes.

Does not require additional hardware

WinPC-NC Economy is operating without any external hardware and is able to control a CNC machine or the drives directly by the controlling signals of the LPT printer port of the Windows PC. Using two LPT ports there are more input signals and additional outputs available.

Realtime abilities of **WinPCNC Economy** however require a personal computer equipped with at least 1 Ghz clocking frequency and operating systems of Win2000 or WinXP.

By 4 stepper motor axes it is possible to realize any 3D mechanics and to use them for various functions. Standard applications contain:

- Drilling
- Plotting
- Grinding
- Dispensing
- Milling
- Cutting foils
- Engraving plates
- Sharpening coin dies

Extensive parameters

The extensive range of options for setting parameters means the program can be adapted to almost all 2-4-axis machines.

Clearly structured operator interface

WinPC-NC offers a well thought-out and modern operating concept incorporating drop-down menus and a windows management system with mouse and keyboard operation. This makes it easy to learn and master the program.

Runs on any modern PC

All that is required for operating **WinPC-NC** is a commercially available personal computer with a hard disk, LPT printer port, USB port, any graphics card and MS-Windows 2000 or XP.



Sample of a 3 axis milling plant

Special features

Special features of WinPC-NC Economy:

- 32-bit arithmetic for an almost unlimited working range
- according to industry standards it is controlling by clocking/direction signals any commercial stepper motor cards and producing stepping frequencies up to 24 kHz
- as an alternative a version for the commonly known SMC stepper motor cards is available, however with restrictions of the card itself
- jog mode in exact steps using the cursor keys or the mouse
- graphical display with scale, zoom, shift, turning and reflecting functions
- runs under Win2000 and XP without restrictions (date 6/06)
- axis resolutions, speeds, backlash compensation, ramp length for the X/Y and Z-axis can be set within generous limits. The 4th axis can be programmed as U, V, W, A, B or C or tangential axis.
- reference and limit switch interrogation, max. 10 inputs and 8 additional outputs can be set within generous limits on LPT1+2
- recognizes HPGL, DIN/ISO, MultiCAM 2D and 3D, drilling formats, ISEL NCP, EPS and AI

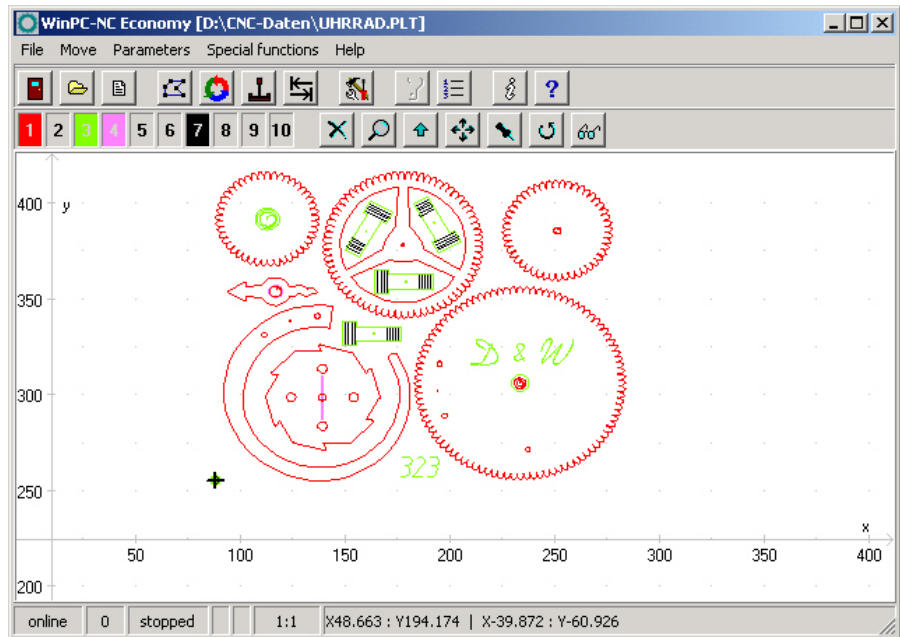

WinPC-NC main screen

- extensive tool management function, tools can be selected individually, colors can be set, repetition and feed functions
- speeds can be set between 0.01 and approx. 1000 mm/s
- high-performance integrated editor
- lots of external signals for synchronizing the procedure, e.g. *start signal*, *spindle speed reached*, *machine ready*
- speed control of the drilling/milling spindles, counterclockwise rotation/clockwise rotation
- units of dimension can be set to mm, inch and mm/s, mm/min and inch/min
- multilingual, other languages can easily be retrofitted, ger-eng-ita-turk-spa-port-pol (date 6/06)
- supports various additional signals and sensors
- tool length measurement and compensation
- flexible macro language for running subroutines at various points in the program
- override for feed rate and spindle speed
- comfortable teachin function
- repetitions for mass production
- ..there are many other features besides these

*Also available
for SMC800
and SMC1500
stepper motor
cards*

According to version **WinPC-NC Economy** is also available for the common SMC800 and SMC1500 stepper motor cards. When you order, please note that you have to indicate either clocking/direction or SMC version. Each version disposes of an individual motor signal, a reversal function of the program is not possible.



Using the SMC version and a SMC800 or SMC1500 stepper motor card unfortunately there are not all functions available. This is due to the electrical and technical structure of the SMC cards.

Please consider the following restrictions with SMC stepper motor cards :

- limit of the stepping frequency to max. 5kHz
- not more than 3 axes connectable
- all reference switches and additional inputs can only be connected to one input line on the card.
- further technical details can be obtained by the documentation of the SMC cards

2. First steps

2.1. Requirements to hardware

WinPC-NC Economy is able to control a connected CNC machine and the corresponding drives directly by the LPT printer port. In order to make this procedure possible, a real time driver has been installed in the lowest plane of the operating system providing the necessary timers and mechanisms.

A faultless operation is therefore only guaranteed with Personal computers with certain minimum of requirements.

- modern CPU with at least 1GHz clocking frequency (more than 2 Ghz are recommended)
- Windows 2000 or Windows XP operating systems or succeeding models
- at least one true parallel printer port (onboard or by ISA/PCI plugin card) and an USB port
- standard graphical card, keyboard, mouse, hard disk and other common PC implements

Detailed information and tips for selecting the suitable computer can be learned from further support information documents.

2.2. Possible restrictions during realtime operation

A reliable realtime operation under Windows depends on many different factors and can be affected by many running actions. Disturbances by other programs lead normally to an irregular and rough motor run. Sometimes it can happen that the machine will act completely uncontrolled.

Please avoid background programs

Ill effects concerning realtime ability...

- access to hard disks, diskettes and network system as well as wireless system actions
- battery loading on notebooks or the constant monitoring and measuring of the battery capacity
- virus scan and firewall programs in the background
- Media-Player or other highspeed start-up programs awaiting in the background certain user actions.
- dynamic processor clock frequency changing functions like SpeedStep® or PowerNow®

In general it is recommended to remove or deactivate all programs which are not required. Notebooks often cause much more problems than desktops computers because the essential signals of the printer port often do not meet the electrical requirements.

Detailed information and tips for selecting the suitable unit are given with additional support information.

2.3. Installation

User-friendly installation

WinPC-NC is installed using a user-friendly setup program. Please insert the disk into the drive and wait for automatic installation start. If the installation is not executed, please start the program SETUP.EXE directly from the CD.

The installation wizard then guides you through the entire procedure.



WinPC-NC Economy is delivered together with a USB dongle. Please insert the dongle into the computer after the software has been completely installed and thus the dongle driver is loaded.

Call up the **README** file to learn about important changes to the information in the manual. These changes are additional features included after the manual was written.

List of files

The following files are installed to the target directory :

WINPCNC.EXE	Control program
WINPCNC.WPI or WTI	Parameter file
WINPCNC.WPW or WTW	Tool file
WINPCNC.HLP	Help texts
WINPCNC.LNG	Messages and texts, multilingual
WCNCCON.DLL	Realtime driver
README	Latest changes to the manual
*.DLL	Some files needed in the system folders
*.PLT *.SMM *.DIN	Sample NC files
*.NCP *.EPS	

2.4. Launching the program

WinPC-NC is launched simply by clicking the desktop icon or by means of the start menu. After a short time the window of the realtime module appears in the upper left corner of the screen and in the middle the *WinPC-NC* working screen which is divided into several areas.

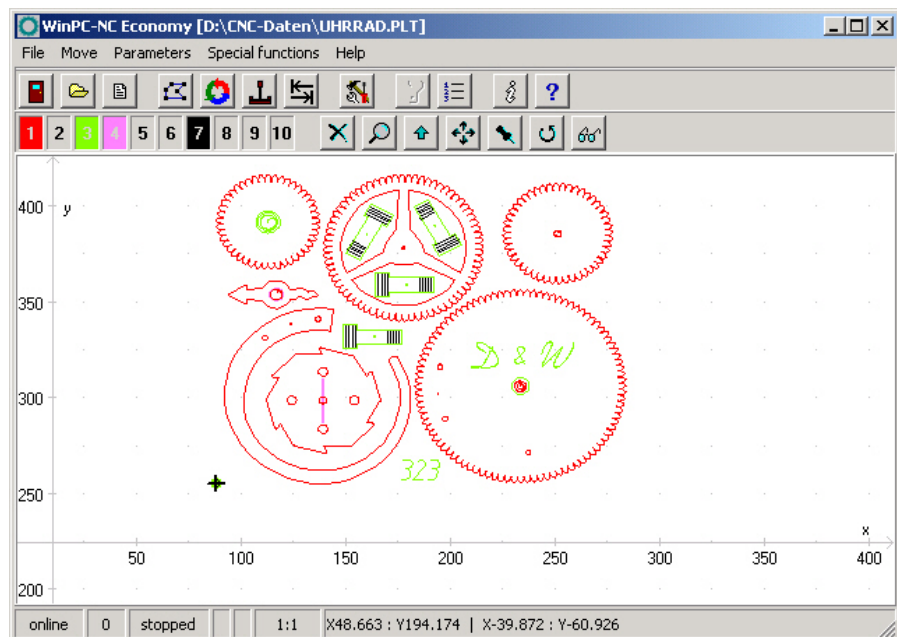

WinPC-NC screen layout

- Title bar
- Menu bar
- Bar with speed buttons
- Toolbar and display buttons
- Display area
- Status bar

Screen layout

The title bar and menu bar are located at the top edge of the screen. The drop-down menus open from the menu bar.

The quick speed buttons enable you to select important functions simply by clicking with the mouse.

The function of the individual buttons is as follows :

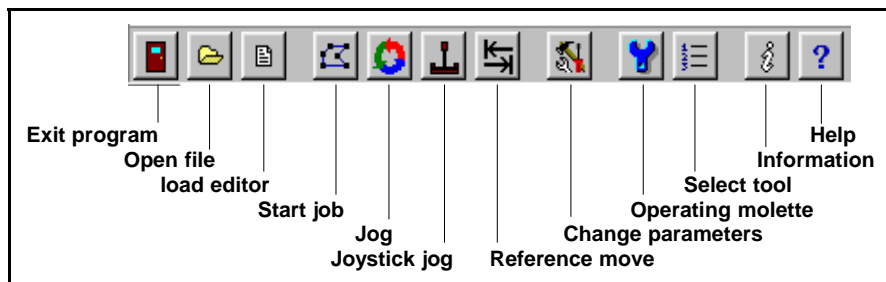

Speed button bar in *WinPC-NC*

The status bar at the bottom displays information about the operating status of the software and the machine, or else a help text about the functions which are currently active. Buttons for operating the display and the tools are located in the second button bar.

The large area is the working area where *WinPC-NC* displays the currently loaded NC file in graphical format.

Realtime module with own window

Actual data information and status are displayed by the realtime module on the left top edge.

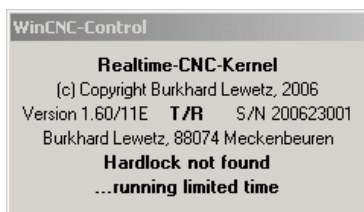

Display of the realtime module if the USB dongle has not been found

The used realtime module displays the version and serial number. Furthermore it can be observed by T/R or SMC whether motor controlling takes place with the clocking/direction or SMC signals.



In case if the delivered USB dongle, which is used as hardware protection, is not recognized, the realtime module is operating only for a limited time. After this test run there is no further communication possible with *WinPC-NC*.

A message is displayed if the USB dongle is correctly recognized and *WinPC-NC* can be used without restrictions concerning time or functions.

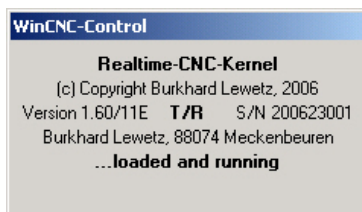

Display of the realtime module if the USB dongle has been correctly recognized

2.5. First setup and test moves

Executing an initial test run with the motors there is nothing else to do than connecting the machine with the LPT port and checking or amending the occupation of the controlling signals.

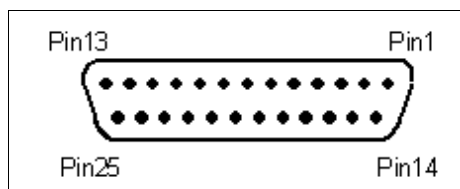

LPT port, pin layout

WinPC-NC is using the following signals for motor actuation...

- Pin 2 direction motor X
- Pin 3 clock motor X
- Pin 4 direction motor Y
- Pin 5 clock motor Y
- Pin 6 direction motor Z
- Pin 7 clock motor Z
- Pin 8 direction motor 4
- Pin 9 clock motor 4



Using a SMC stepper motor card it is not necessary to consider the exact signal assignment. It is sufficient to utilize a commonly used printer cable for connecting LPT port and SMC card.

In order to detect the LPT port address you have to call up the device manager in the system control.

Please perform the following steps...

- open the device manager under *My computer, system control, hardware*
- open the category *connections COM and LPT* and select the LPT port which is connected to the machine
- select by the right mouse button the function *properties* and then *resources*

- note the port address under which the LPT port is registered in the system. With onboard ports it is usually the port address 0378hex.

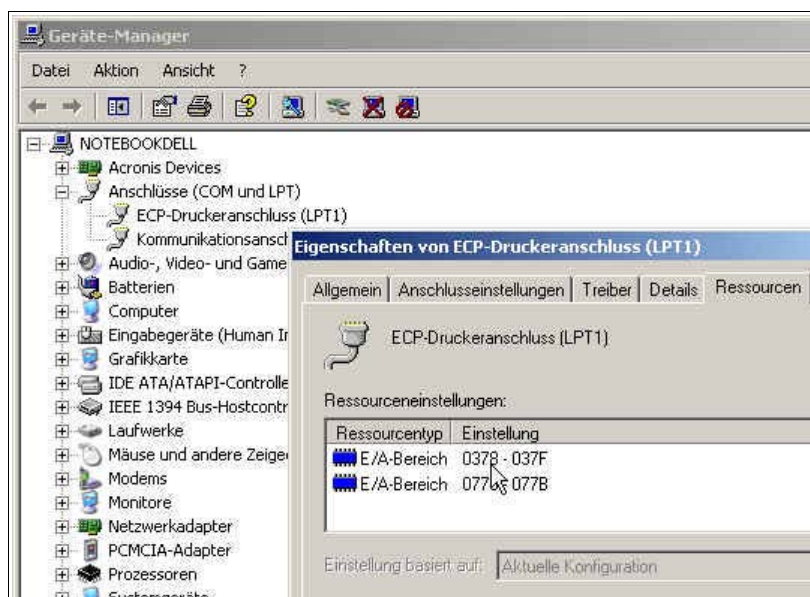

Locating the LPT port by means of the device manager

The detected port address has to be registered in *WinPC-NC* under *parameter-ports- LPT.port address* and complete the process by clicking the function keys *SAVE* and *OK*.

After this procedure it should be possible to perform a simple test run with function *JOG* or *MOTOR TEST*. Please be very careful in performing and be aware of uncontrolled movements of the machine.



When first delivered, the LPT port address is registered with 0378hex. This applies for nearly all internal ports.

Detailed instructions concerning start-up procedure are given in a separate chapter.

2.6. Exiting WinPC-NC

You can exit *WinPC-NC* at any time by clicking the cross in the box at the top right of the window, or by selecting *EXIT* from the *FILE* menu.

3. Operating WinPC-NC

3.1. Graphical display of the NC file

Graphical preview of the NC files The graphical preview function in **WinPC-NC** is activated as soon as an NC file is selected. All contours or vectors can be seen in the tool color.

In addition, two rulers can be seen with the current dimensions and positions. The workpiece zero point is identified by a small black dot and the current machine position as a small red dot.

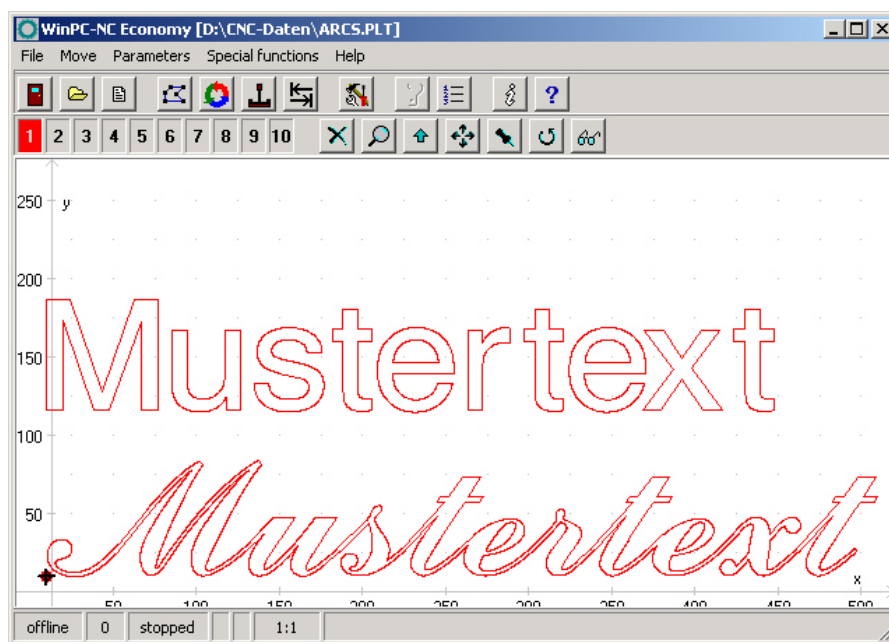

Graphical display of the NC file



3D data in DIN/ISO programs are only displayed in the X/Y plane, while different Z-axis heights are displayed using colored shading.

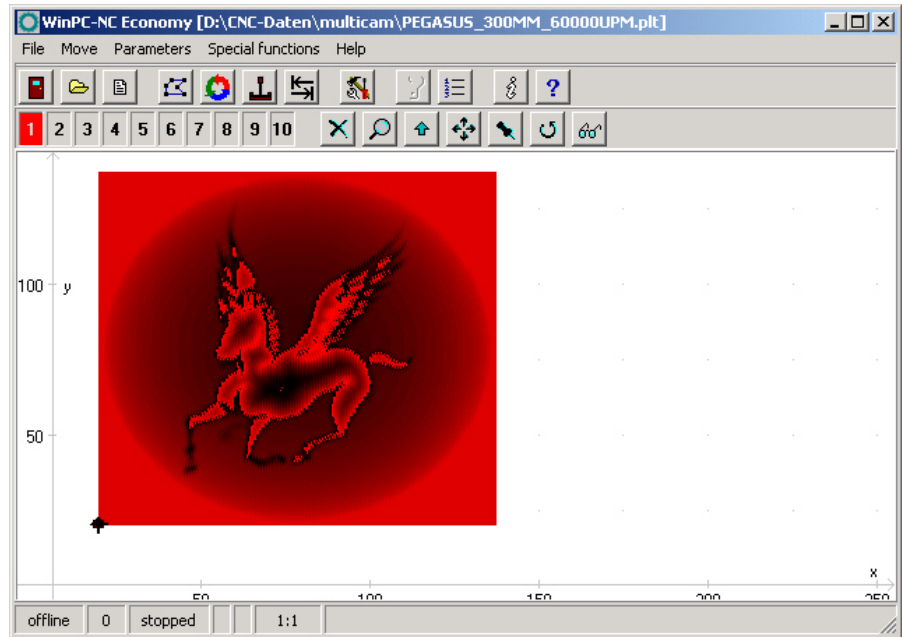

Graphical display of a 3D file with colored shading

The following actions are possible on the graphical display :



Zoom

With the zoom function, it is easy to view certain sections of the screen in a magnified view. After you select the function by clicking the zoom button, the cursor appears as a cross and you can click and drag a rectangle to select the required area.

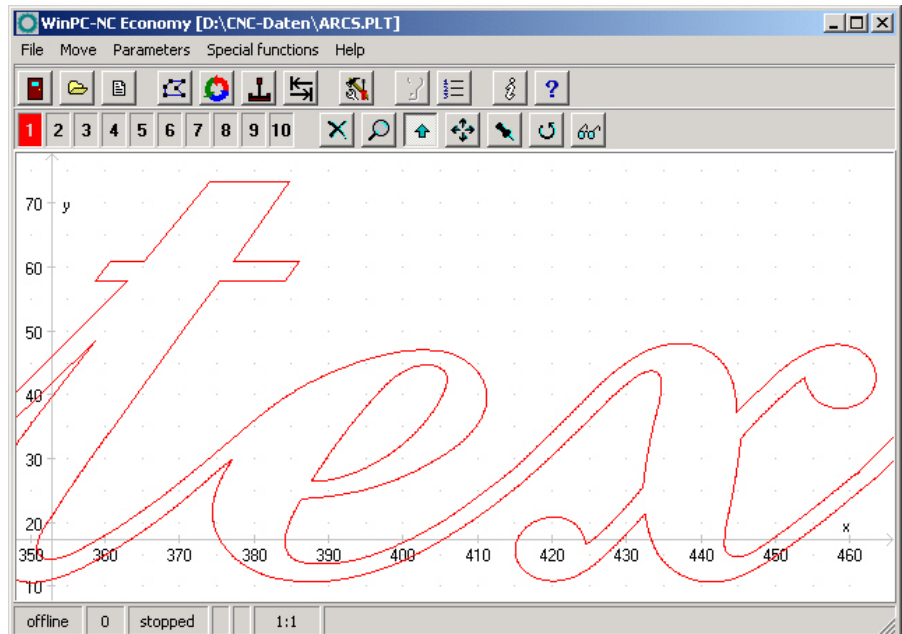

Zoom in the graphical display of the NC file



Move

The move function makes it possible to use the mouse to move a zoomed image and enables you to view another part of the NC file in greater detail. After the function has been activated, the cursor

appears as a hand. With it, you can click and drag any point to move the image to where you want.

The movement track is displayed as a line while you are dragging. Once you release the mouse button, the graphic appears in the new position to where you have moved it.



Display original size

Clicking this symbol restores the original size and position. This undoes all zoom and move actions.



Define current machine position

The current machine position is represented by a small red dot in the graphic. Using the function described here, you can position the NC file in the way that the current machine position corresponds exactly to a point or a certain position in the file. The file zero point is simply recalculated internally.

Using this method it is quite simple to position the workingpiece and the NC file with great accuracy.

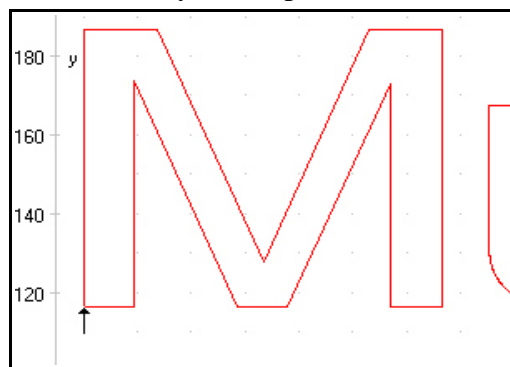

Cancel function

Once a zoom, move or positioning action has been started, it can be cancelled by clicking the cancel button. The cursor reverts to its normal arrow shape.



Turning data

By clicking the *TURN* button it is possible to turn the indicated data by 90°. In this way it is easier to place the data on the material.



Selecting the display area

By means of the button *AREA* the graphical display can easily be changed. So it is possible to display only the piece to be produced and its corresponding data. There is also the possibility to display the defined workpiece area or the stipulated machine size with the current position. In this way it is easy to recognize the location of the piece and whether it can be worked without any problems within the defined limits.

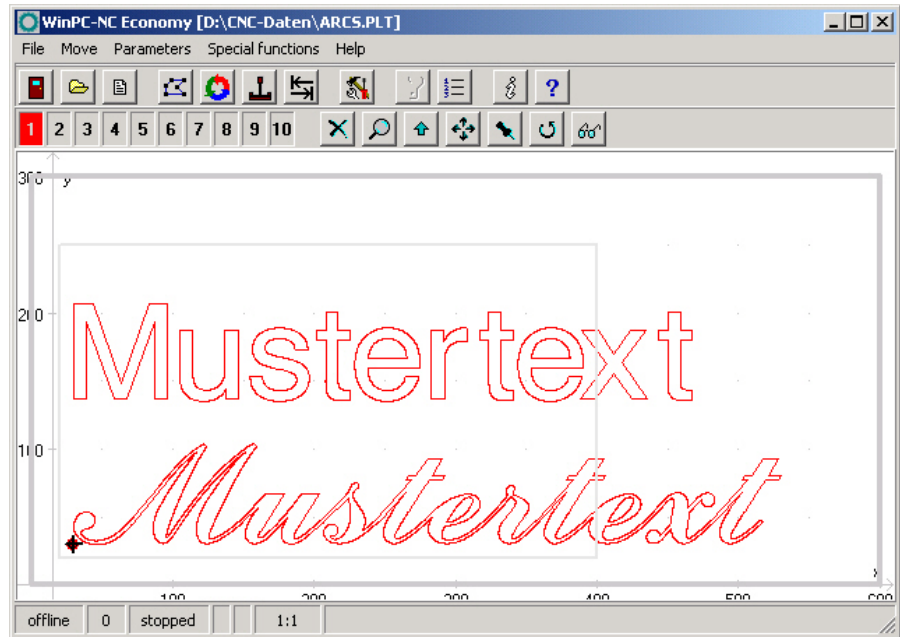

Display with machine table and working area



Set tools active/inactive

All tools which are used in an NC file are displayed along the lefthand edge in the tool frame. They are shown using their current colors. A tool can be deactivated or activated simply by clicking the tool box. Switching in this way has the same effect as activating it in the parameters. Once tools have been switched, they immediately appear in the graphical display.

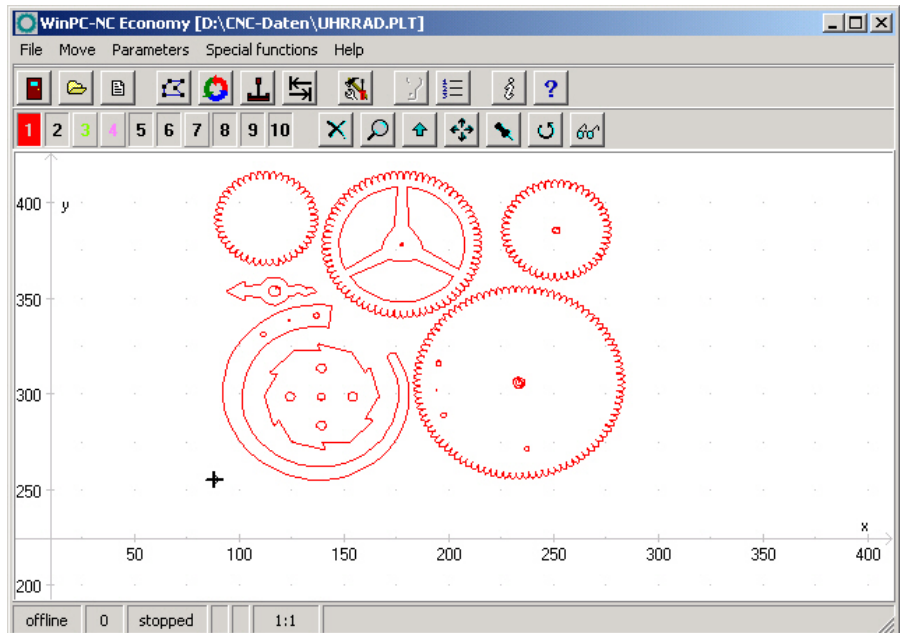

Graphical display with inactive tools

3.2. Drop-down menus and function keys

Modern interface

WinPC-NC has a modern user interface. All functions can be activated by drop-down menus. In addition, frequently required functions can be activated quickly using the function keys or speed buttons.

The drop-down menus are divided into several functional groups, e.g. all functions concerned with selecting and editing files are grouped together in one menu. All parameters and tools are set using another menu.

The menu system is opened or activated by clicking the menu item or pressing one of the shortcut keys for the individual menus.

Additional function keys

Important functions can also be activated using function keys. The function key assignment is fixed and indicated in the menu functions.

The most important function keys are :

(F1)	Activate the help system
(F2)	Load new NC file
(shi ft-F2)	Load parameter file
(F3)	Start job process
(F5)	Jog
(shi ft-F5)	Joystick jog
(F7)	Load active or new file into the editor
(F8)	Start reference move

3.3. The individual menus

The following text describes all the menus and functions in detail.

Not all menu items are active all the time. Functions are sometimes unavailable, depending on the program status. For example, it is not possible to use the joystick if it has not been defined in the parameters.

3.3.1. File menu

The FILE menu combines all functions used for selecting files to process and analyse them. In addition, it is also possible to exit **WinPC-NC** here.

Open	F2
Open without parameters	F7
Editor	F7
Exit	

Press the alt (-D) shortcut key to open the file menu.

FILE-OPEN

*File selection
by menu*

The FILE-OPEN menu item calls up an interactive function for selecting a NC file.

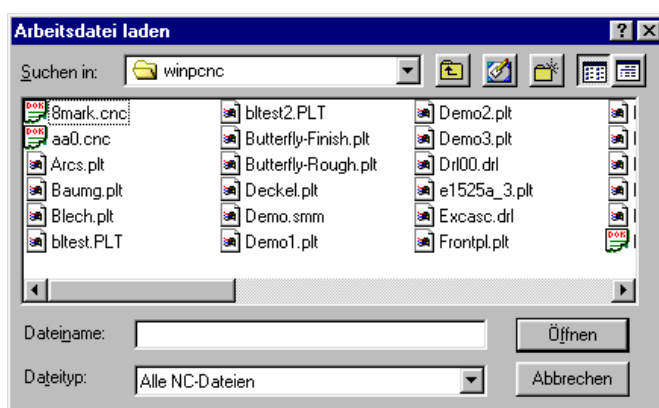

File selection dialog box



In the dialog box, it is possible to change drives and folders, as well as to activate filters for certain file name extensions. The file selection function can also be activated using function key (F2) or by clicking the open button.

*Graphical preview
of an NC file*

The graphical preview function in **WinPC-NC** is activated as soon as it is selected. All contours or vectors can be seen in the corresponding tool color.

FILE-OPEN WITHOUT PARAMETERS

The second *OPEN* function only loads the corresponding NC file without taking account of any project parameters. All current parameter settings remain valid.

FILE-EDITOR

*Revising
NC data*

The *EDITOR* menu item activates the editor for creating or revising the NC files.

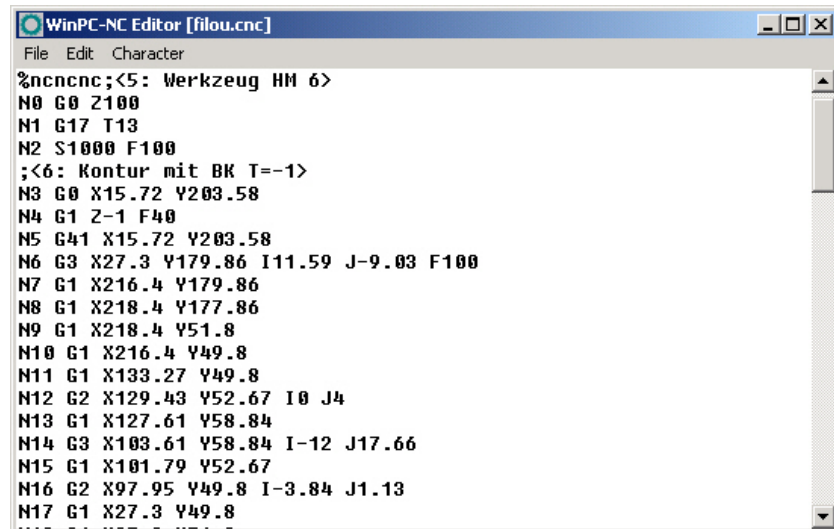

```

WinPC-NC Editor [filou.cnc]
File Edit Character
%ncncnc;<5: Werkzeug HM 6>
N0 G0 Z100
N1 G17 T13
N2 S1000 F100
;<6: Kontur mit BK T=-1>
N3 G0 X15.72 Y203.58
N4 G1 Z-1 F40
N5 G41 X15.72 Y203.58
N6 G3 X27.3 Y179.86 I11.59 J-9.03 F100
N7 G1 X216.4 Y179.86
N8 G1 X218.4 Y177.86
N9 G1 X218.4 Y51.8
N10 G1 X216.4 Y49.8
N11 G1 X133.27 Y49.8
N12 G2 X129.43 Y52.67 I0 J4
N13 G1 X127.61 Y58.84
N14 G3 X103.61 Y58.84 I-12 J17.66
N15 G1 X101.79 Y52.67
N16 G2 X97.95 Y49.8 I-3.84 J1.13
N17 G1 X27.3 Y49.8

```

NC file in the integrated editor



The editor can also be activated using function key (F7) or by clicking the editor button.

FILE EXIT



You can select the FILE EXIT menu item to exit *WinPC-NC*. Clicking the exit button has the same effect.

3.3.2. MOVE menu

Functions for moving the machine

The *MOVE* menu groups together all functions which are used for controlling the machine and the tool changing.

Start	F3
Jog	F5
Joystick jog	shift-F5
Reference move	F8
Select tool	

Press the (Alt-F) shortcut key to open the menu.

MOVE-START



After a working file has been loaded, the *START* menu item can be used for processing the job. Pressing the (F3) key or clicking the *START* button has the same effect.

WinPC-NC controls the X and Y motors during move commands. The Z motor moves up and down during tool movement commands. All three axes can move at the same time in 3D files.

Progress display During machining, a window displays the progress as a percentage. In addition the realtime file display is available where the current performed command line is marked by a cursor bar.

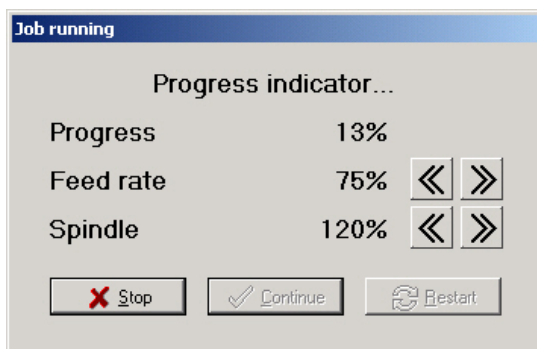

Display of progress and speed override

Speed override Clicking the greater than/less than button in the window makes it possible to change the feed rate of the machine as well as the spindle speed in 5% steps. The valid range is from 10% to 200%.

A working process can be cancelled by clicking the *CANCEL* button in the progress display window, or by pressing the (ESC) key. The machine brakes all axes without losing any steps and switches off the spindle and the cooling function.

Resuming an interrupted job When you start again after a cancel, **WinPC-NC** asks whether the interrupted process should be resumed from the point where it was cancelled, or whether the process should be started over again. During an interruption, it is possible to change parameters, clean the tool or even perform jog movement and homing the machine.

The continuation of an interrupted job has to be enabled in the parameters.

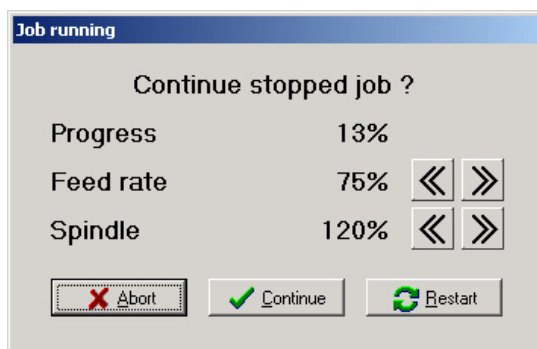

Continuation of an interrupted job

MOVE JOG



The *JOG* menu item calls up the manual setup function for the machine. This function can also be accessed by pressing the (F5) function key or with the jog button.

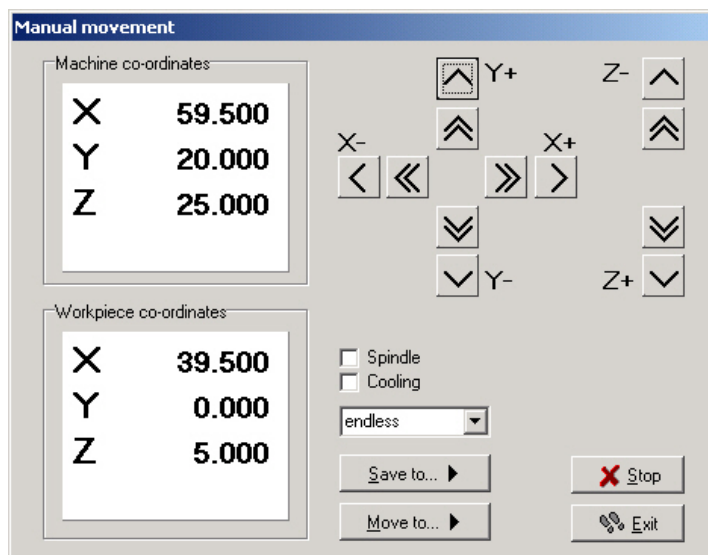

Jog function

Exact movement with the keyboard or mouse

In *JOG* mode, it is possible to move all motors step-by-step or continuously with the white arrow keys or with the mouse. Pressing a key briefly or clicking the corresponding direction button causes only one motor step to be performed. Pressing the key for longer or keeping the mouse button pressed causes the motor to move continuously. The changeover time can be defined as a parameter.

Only slow movements are possible using the PC keyboard, whereas with the mouse the double arrow buttons can be used for fast movements and the other buttons for slow movements. The speeds are defined in the parameters.

Display of the step counter

The absolute step counters for each axis are displayed in the top part of the window. Their values relate to the reference point on the reference switches. Below them are located the relative step counters which relate to the zero point of the working piece.



WinPC-NC distinguishes between two systems of coordinates. Firstly the machine coordinates with their origin on the reference switches and which are referred to as the reference point. Then there are the workpiece coordinates with the workpiece zero point, which is usually located in the bottom left-hand corner of the data area.

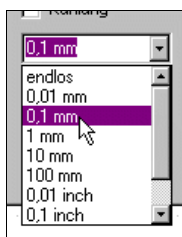

WinPC-NC can move the axes endlessly, i.e. movement continues for as long as a key remains pressed. The axis brakes when the key is released and comes to a stop without any step losses. The second possibility involves moving discrete distances. Distances between 0.01mm and 100mm are possible, as well as inch dimensions. The currently set distance is displayed in the window. **WinPC-NC** moves this distance in any required direction and with both possible speeds, depending on which button or key is pressed.

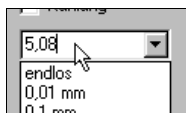

In addition to the predefined distances, it is possible to enter any distance in the text box.

Switching additional signals

Clicking the check boxes with the mouse is all that is required to switch the additional signals *drilling spindle* and *coolant pump*. This switches the signals on or off. Both signals are switched off when you exit the *JOG* function.

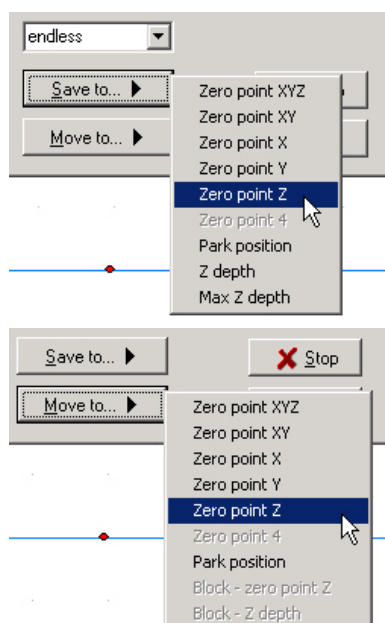

During manual movement, it is possible to move and store certain help points. After a position has been reached, it is easy to click the *Save* button to select the required point and save it permanently as a parameter.

Moving to saved help points is just as straightforward. All that is required is to click the *Move to* button and select the required help point. Then the machine moves to it.

Movement in progress can be interrupted at any time by clicking the *Stop* button.

The *JOG* function can be exited by clicking the the *Exit* button.

Automatic measurement of Z-heights

WinPC-NC can automatically determine the various Z-axis heights using a probe or surface block sensor. The sensor should be connected to an input on the LPT port using a cable to allow the block sensor to move freely. Depending on which Z-axis height you are measuring, place the probe against the clamped workpiece or the table surface to measure the maximum Z-axis depth

The measuring sequence involves several steps :

1. Move the machine over the point to be measured
2. Place the probe or surface block onto the piece but under the tool.
3. Start the measurement. **WinPC-NC** moves the Z axis downwards slowly until the probe contact trips. Then the axis stops and **WinPC-NC** transfers the measured value and the probe width as parameters. The probe width can be defined as a parameter.

Setting up the 4th axis

If a 4th axis is available, the appearance of the jog dialog box is somewhat different. In this case, it also includes buttons for moving this axis slowly and quickly, as well as boxes for displaying the axis positions.

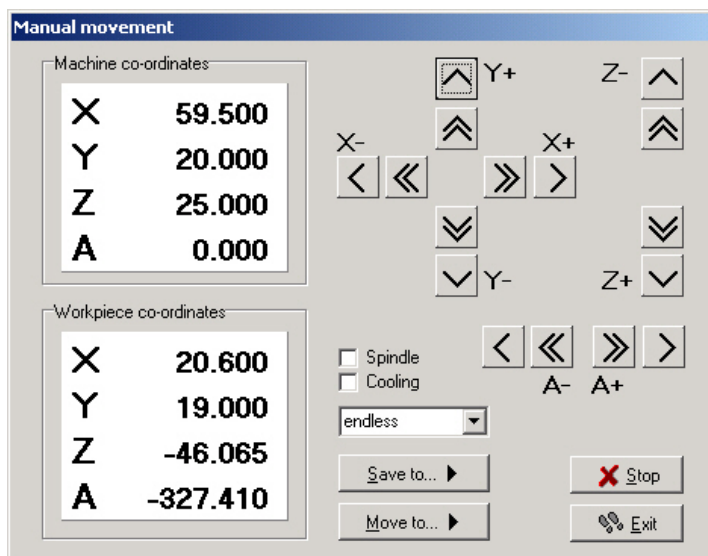

Jogging with the 4th axis

MOVE JOYSTICK JOGGING



As an alternative to the mouse and keyboard, it is also possible to move the machine manually using a connected joystick. This is of advantage for observing the movements directly on the machine and setting exact positions. It is easier to take a joystick to the machine than keyboard or mouse.



Prior to use a connected joystick it must be configured in the Windows system and calibrated with a special function.

Jogging with joystick

When setting up the machine with the joystick, movement in the X and Y-axis directions can be achieved simply by tilting the control handle. Moving the Z-axis requires pressing joystick button 1 as well.

A help point can also be stored directly at the machine using the joystick. The stored position can be selected by repeatedly pressing joystick button 2. To store the position itself, press button 2 at the same time as holding button 1 pressed.

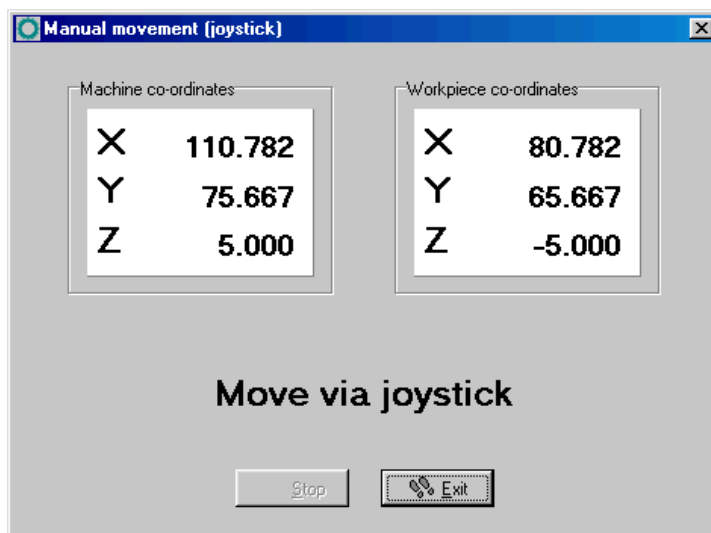

Manual move with joystick

MOVE-REFERENCE

The function *REFERENCE MOVE* also called homing runs all axes to the reference switches in a defined sequence.

Reference point of the machine

Every axis starts moving at reference speed 1 and searches for the reference switch of the machine. Movement stops when the switch changes its level. Then movement starts at speed 2 in the opposite direction back away from the switch. The edge of the reference switch defines the reference point for this axis.

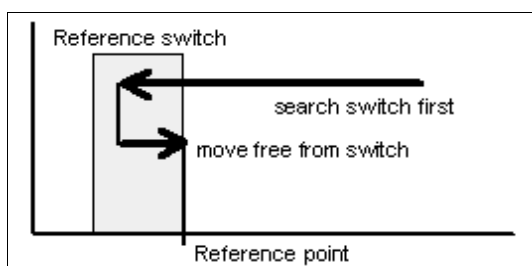

Sequence of reference movement to the reference switch

WinPC-NC needs to know the current positions of all axes. As a result, reference movement is essential before a working process.



Reference movement is also triggered by pressing the (F8) key, or using the *reference* button.

MOVE-SELECT TOOL...



There is a special dialog box for controlling the tool change or if tool length measurement is activated. It can be activated using the menu function or the *tool list* button.

The dialog box contains the following possible functions :

- Place an inserted tool in the magazine
- Pick up a new tool
- Measure the length of a tool
- Identify the tool which has just been inserted

As a rule, *WinPC-NC* always remembers which tool was used last and the status of the collet chuck. As a result, this information is retained over more than one session.

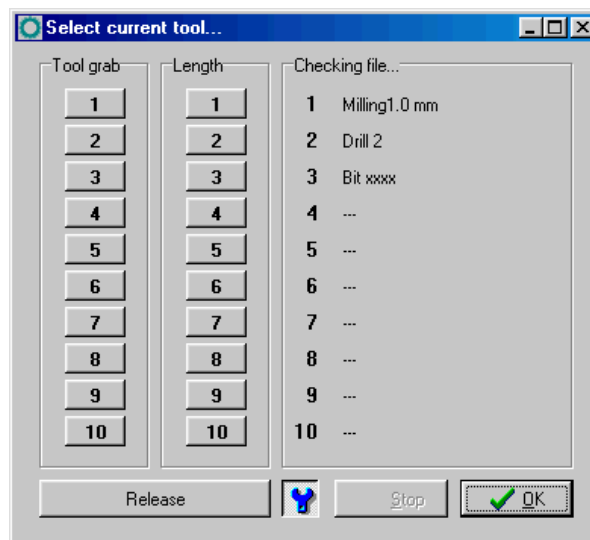

Dialog box for selecting, picking up, putting down and measuring tools

Rapid operation with buttons

Funtion of buttons :

- *Release* takes the currently clamped tool and puts it down in the magazine
- The molette button closes or opens the molette. There is a security prompt prior to opening it
- *Stop* cancels a movement, e.g. to the changer or a measuring movement
- *OK* closes the dialog box



To inform *WinPC-NC* which tool is currently inserted, all you have to do is click the tool number or name on the right. This may be necessary after the initial startup or following a cancel.

3.3.3. PARAMETERS menu

The PARAMETERS menu contains all the setting options for *WinPC-NC*. It is made up of several dialog boxes which contain the parameters grouped by function.



The shortcut key for activating the *PARAMETERS* menu is (Alt-P) . Clicking the *parameters* button has the same effect. The individual parameters are explained in detail in a subsequent chapter.

PARAMETER-SAVE

Saving parameters specifically for a project All parameter and tool settings can be stored in files using the *SAVE* menu item. It is possible to save the settings for a working file or for a project.



The *Save* function operates as follows : When a working file is loaded, *WinPC-NC* stores all workpiece-related settings such as the zero point, scaling, etc. in a parameter and tool file associated with the working file. The files have the same name as the working file, with the endings*.WPI and *.WPW, z.B. HOLDER.WPI or ENGRAVING.WPW.

Whenever these working files are loaded in the future, all the settings and tools are once again available without having to be redefined.

The machine-related parameters such as axis resolution, reference directions or the interfaces used are always stored in the standard parameter file WINPCNC.WPI.

If no working file is selected when you save, the *Save* function stores all settings in the default files WINPCNC.WPI and WINPCNC.WPW.

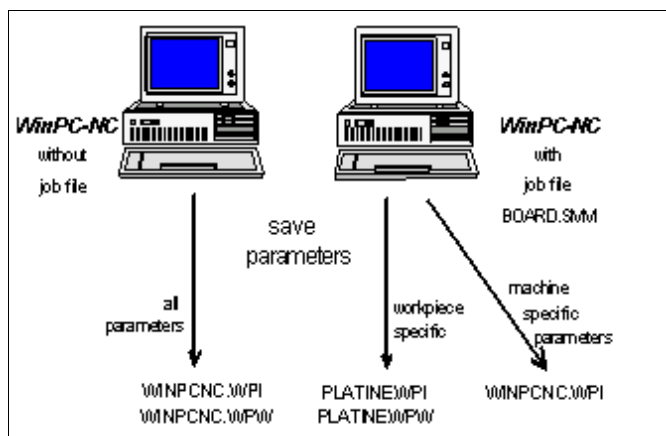

Saving parameters and tool settings

Subdividing between two parameter files offers the advantage that all machine parameters only have to be saved once, and they only have to be saved in this file whenever changes are made.

PARAMETERs SAVE AS...

The second *Save* function allows you to enter any file name for the project parameters. In this way it is possible to produce parameter settings for various operating procedures or materials.

PARAMETERS-LOAD...

Loading specific parameters records

The *LOAD* function enables you to load various specific parameters, e.g. for different materials or working processes.

A window appears with the familiar *open* dialog box functions. It is possible to select parameter or tool files.

The *PARAMETERS-LOAD* function can also be activated with (Shift-F2).

3.3.4. SPECIAL FUNCTIONS menu

The *SPECIAL FUNCTIONS* menu gives you access to two test functions which you can use to systematically check the mechanics and to ascertain what are the correct or optimum parameter settings. Also, a joystick calibration function and a position check function are integrated here.

- Signal test
- Motor test
- Status information
- Joystick calibration
- Check position
- Teachin

SPECIAL FUNCTION-SIGNAL TEST

This test function can be used for checking the axis inputs of the controller, i.e. the limit and reference switches, as well as the outputs.

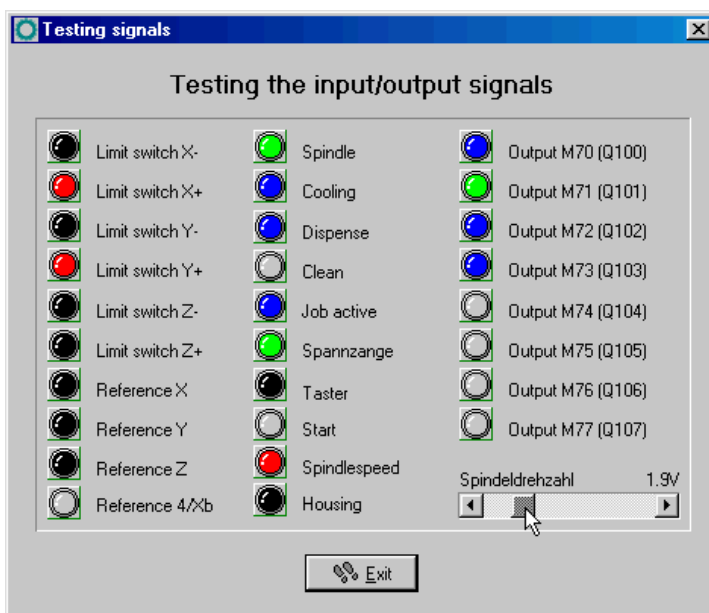

Signal test

Interactive testing of all inputs/outputs

WinPC-NC continuously interrogates the limit switches and reference switches on all supported axes and displays their status. Grayed out switches are not defined.

Black indicates the switch is not active, while red displays that the switch is activated.



Definiton of the switches and setup of the switching logic must be executed during installation by the signal wizzard under *parameter-machine-signals*.

The supported additional signals are tested by simply clicking the LED symbols. This switches the outputs on or off.

Testing the spindle speed

There is a slider in the bottom right-hand corner of the window. This sets the analog output for checking the spindle speed. It can be infinitely varied between 0V and 10V and outputs this value binary coded by an optional LPT2 port.

SPECIAL FUNCTIONS-MOTOR TEST

The *MOTOR TEST* special function is used for ascertaining the optimum speed settings. A window displays all parameters relevant to the step calculation.

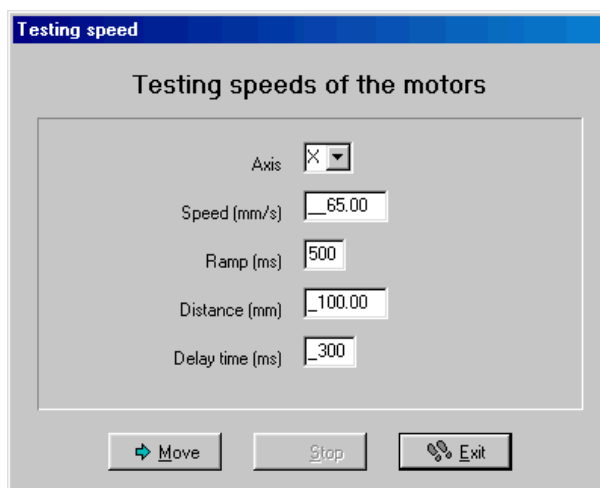

Motor test

The required values can be entered in the parameter boxes, after which a test run can be performed immediately in order to check all parameters.



Clicking the *Move* button causes *WinPC-NC* to move the selected axis continuously forwards and backwards. By listening to and observing the movement, it is easy to tell whether the parameters are correct for the axis, or whether additional corrections are needed to the speed or ramp length. The test run is cancelled by pressing the (ESC) key or clicking the *Stop* button.

Optimum parameters

The optimum values for an axis have been achieved if the motor starts up quickly without step losses, and is still able to develop sufficient torque at maximum speed.

Step-by-step setting

Step-by-step procedure for testing X/Y and Z-axis :

1. Switch off the ramp length and slowly increase the start/stop speed until the motor stalls. Then reduce the speed value by 30-40%.
2. Test the ramp length with various values. You have achieved a good value if the motor starts up quickly without stalling.
3. Increase the rapid speed in stages. The motor should run quickly while still developing sufficient torque.

Having ascertained the values, you can store them as parameters for the axis in question. All parameters and their functions are explained in a subsequent chapter.



The optimum parameters for a stepper motor axis depend on many factors, e.g. the motor characteristic, the type of drive used (spindle or belt) and the load to be moved.

SPECIAL FUNCTIONS-STATUS INFORMATION

*Informationen
about the
realtime module*

WinPC-NC Economy works only in conjunction with the realtime module WCNCCON.DLL. The special function *Status information* reads out and displays the version and serial number of it.

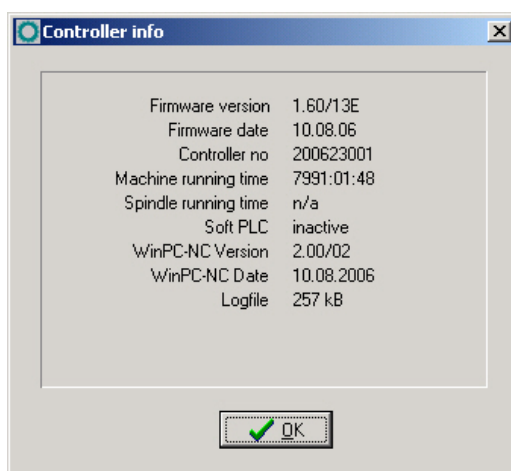

Display of the realtime module version

Whenever you have any queries for the manufacturer, always provide the version number of the realtime module and the controlling number as well as the version of **WinPC-NC**.

SPECIAL FUNCTIONS-JOYSTICK CALIBRATION

To be able to move the machine with a joystick, **WinPC-NC** needs to know the type and value ranges of the joystick signals. The *JOYSTICK CALIBRATION* function does this almost automatically.

*Determination
joystick para-
meters menu*

Instructions for operating the joystick are displayed in a window. Please follow these instructions exactly. The procedure involves pressing both buttons and moving the lever to certain positions.



The joystick cannot be used before it has been calibrated.

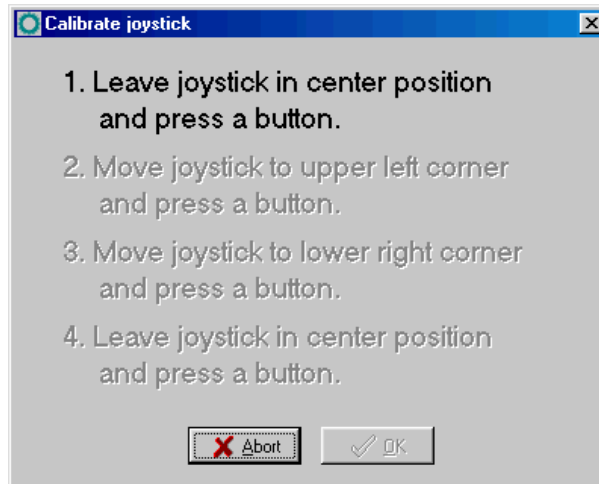

Joystick calibration

SPECIAL FUNCTIONS – CHECK POSITION

The *CHECK POSITION* function is another test function in *WinPC-NC*. It can be used for checking the accuracy of the reference switches.

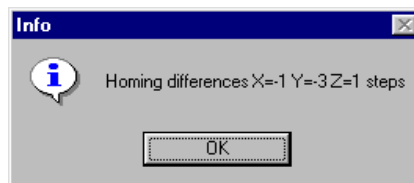

Result of the position check

Check reference position

Relatively small step discrepancies may be due to the switches. Large discrepancies, on the other hand, indicate previous step losses.

It is a good idea to use the CHECK POSITION function if:

- you presume steps have been lost due to a collision
- you want to determine the maximum machining speed for a tool or a material, which means you want to demonstrate whether or not steps have been lost
- the position was changed during a tool change



It is only possible to check the reference position if reference movement was performed previously and there was no cancel due to a limit switch or a stop signal.

SPECIAL FUNCTION-TEACHIN

By means of the function *TEACHIN* simple programs in various formats can be created by moving and following the contours.

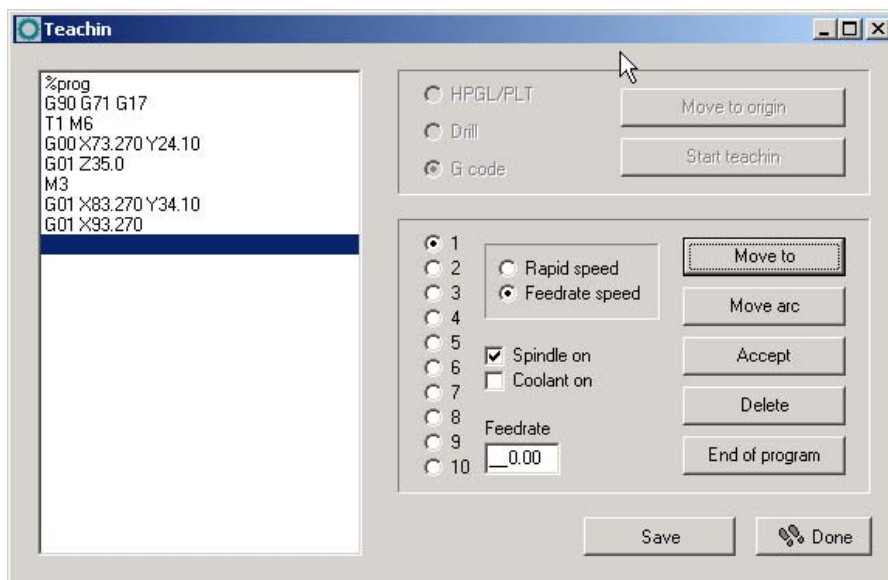

Special function teachin

Creating programs interactive

The new program is displayed in the teachin window on the left side of the dialog. In the top part actions can be activated prior to the teachin process.

The large window on the right-hand displays all available actions, e. g. selecting the tool, speed settings, operating the spindle and cooling and provides the possibility to produce various contour shapes.



Executing commands depends on the selected data format. Commands as switching the spindle or cooling are useless with the HPGL format.

Teachin step by step

Gradual procedure with teachin :

1. Execute reference move and call up teachin function
2. Stipulate the desired data format and determine the zero point by moving
3. Start teachin process. Now the program head will be automatically set up and displayed in the program window.
4. In the following steps you can create as many contour elements as necessary for the desired program either by moving the new line ends or by definition of circle points. Tool changes and unproductive movements to new start points and plunge positions are possible.

5. Click on *exit* button and the program is automatically finished.
6. The new created program should be stored before leaving the function.

Possible actions during the teachin process are as follows :

<i>Move line</i>	Moving to a new position. This moving step is either an operation in open circuit with high speed or immersed with feed rate. Several lines can be taught successively and the function is left if no other movement has taken place.
<i>Circle arc</i>	Teachin of a circle or arc is taking place with always three points. The first point is also the current position. First any point on the circle arc is being moved to and finally the final point. By these three points a circle or arc command can be clearly created.
<i>Accept</i>	This function inserts the actual position of to the cursor bar into the program.
<i>Delete</i>	Deletes the line of the cursor bar. With this function it is also possible to delete and correct previous commands.
<i>Exit</i>	Inserts the necessary commands for exiting the program and finishes the new created NC program.



New commands are always inserted at the actual cursor position and enables the user to make up for overlooked actions.

3.3.5. HELP-menu

There are three items in the help menu:

Help topics... Liability About WinPC-NC
--

HELP-TOPICS

The *HELP TOPICS* function gives you access to the help system. A dialog box appears containing the main selection.

HELP-LIABILITY

The *HELP-LIABILITY* function displays a text with the license conditions and a disclaimer. Please read this information carefully before using *WinPC-NC*.

HELP ABOUT *WinPC-NC*

Activating this menu function displays information about the current version and revision number.

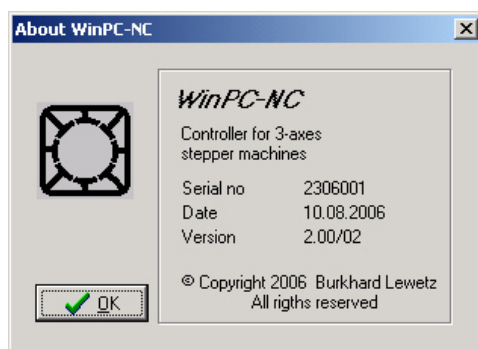

Information about the current version

4. Parameter settings

4.1. Tool management

Project-related tool management

WinPC-NC has a user-friendly *tool management* function. It is possible to define up to 10 tools with specific values for each working project.

The parameters are divided between several dialog boxes. **WinPC-NC** stores all the values defined in these dialog boxes into the tool file using the PARAMETERS-SAVE menu function. Tool files have the *.WPW filename extension.

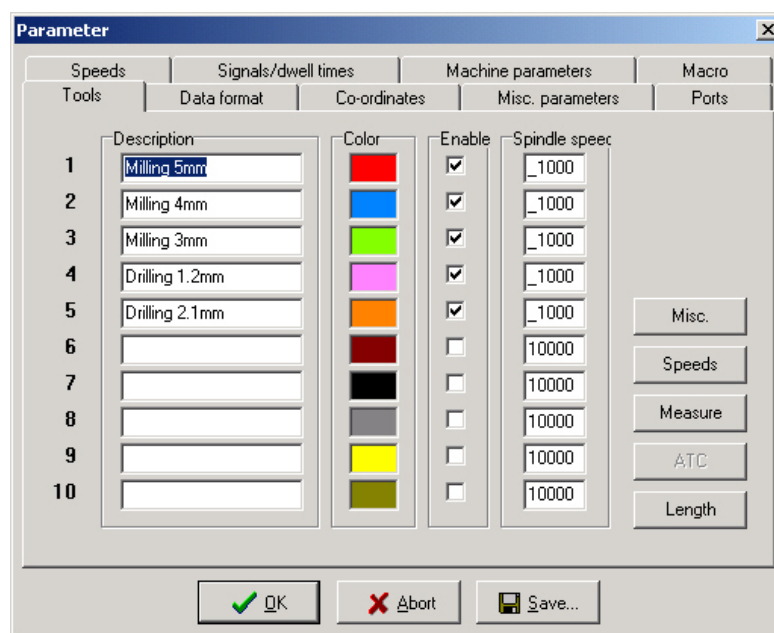

Tool management (window 1)

Designation

Meaningful tool names

Each tool is identified with a name which is used during tool change prompts.

Color

Colors in the graphical display

The *Color* parameter for each tool is used in the graphical display of the data. As a result, it is easy to adapt the color display to suit your own requirements or to harmonize with the CAD program you are using.

Clicking the colored box opens a dialog box in which you can select a new color. All colors supported by the current Windows display settings can be selected.

Activation

Activating tools individually

Each tool can be individually enabled or blocked. Inactive tools are simply ignored in the graphical display and the commands for them are skipped.

Spindle speed

It is possible to assign a spindle speed to each tool. This is set using a defined analog output when the tool is used.

Tool speeds

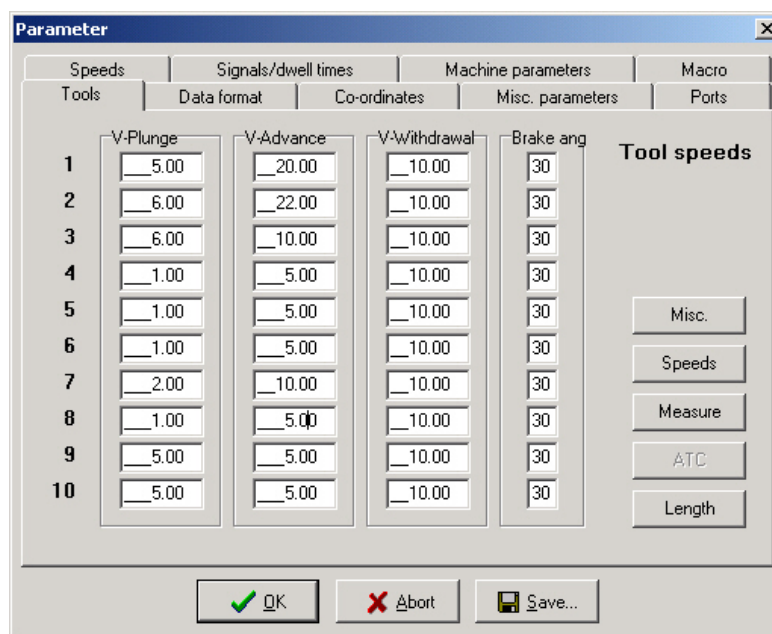

Tool management (window 2)

Plunge speed

The plunge speed specifies the speed with which each tool is pushed into the workpiece. It is necessary to consider certain limit values here, depending on the material and the tool.

Advance speed

The advance speed or feed rate defines the working speed for each tool when the tool is pushed into the workpiece.

This value is irrelevant for straightforward drilling applications. However, if *WinPC-NC* is used for milling, engraving or grinding, then the maximum feed rate depends on the tool used and the material.

Withdrawal speed

The withdrawal speed is used for raising or withdrawing the tool from the workpiece.

Brake angle

The brake angle specifies the maximum angle differential for subsequent movement stages in which movement takes place at full speed. The value is entered in degrees.

*Deterministic
speed
optimization*

Between the start and finish of movements, the acceleration and braking function is only activated if the direction of the next vector deviates from the previous one by more than the defined brake angle.

An example of this deterministic speed optimization function can be seen in movement around a circle, which consists of lots of little individual vectors. The directions of two successive movements are only slightly different. As a result, the circular path can be moved in one operation at maximum speed.

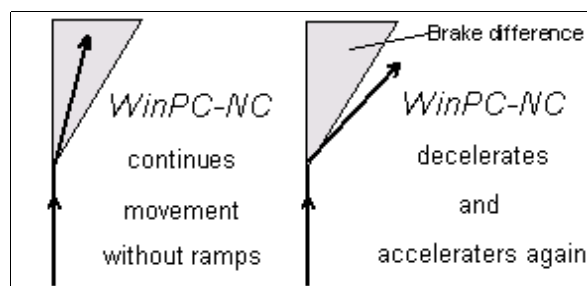

Brake difference

Braking and acceleration always take place before and after tool movements. This parameter is irrelevant in straightforward drilling applications and is ignored.

Tool dimensions

Tools	Depth	Repetitions	Z feed correction
1	3.40	3	0.50
2	3.70	0	0.00
3	0.60	0	0.00
4	5.00	0	0.00
5	5.10	0	0.00
6	5.32	0	0.00
7	6.00	0	0.00
8	1.00	0	0.00
9	1.00	0	0.00
10	1.00	0	0.00

Tool management (window 3)

Plunge depth

The plunge depth specifies the distance by which the Z-axis of each tool is moved downwards into the workpiece. The depth is defined in millimeters and is always measured starting from the plane of the zero point.

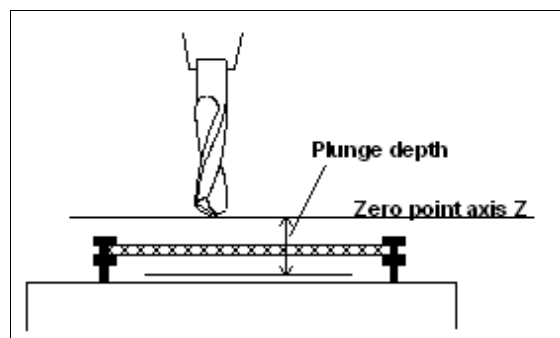

Plunge depth measured from the zero point of the Z-axis

Repetitions

Routing in stages

Frequently, several passes are required when routing thick or hard materials. The parameters *Repetitions* and *Z feed correction* mean you do not have to restart a working process several times in succession using different plunge depths.

The repetition always applies to a complete contour line or for a hole, i.e. *WinPC-NC* remembers every insertion point and returns to it after the tool is next withdrawn, in order to start the next pass.

Z-axis feed correction

During a series of repetitions, the Z-axis feed correction causes the Z-axis to be moved downwards by the specified value.

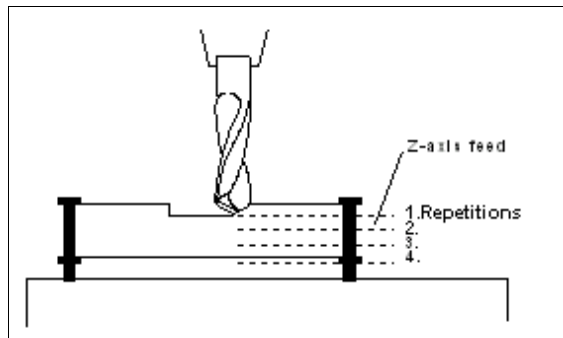

Repetitions and feed correction

Tool length measurement and compensation

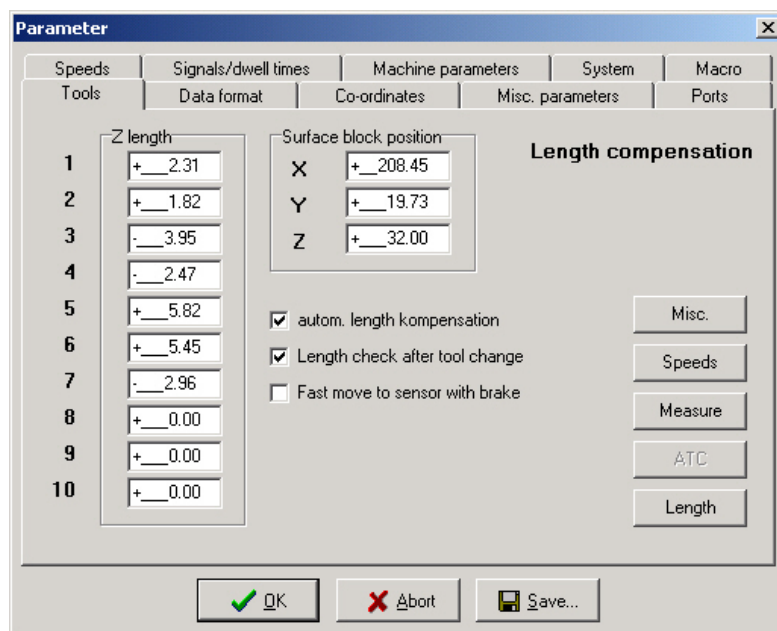

Tool management (window 5)

Compensation of various tool lengths

Working with different tools it usually does not happen that all tools are of the same length. Therefore it is considerably difficult to determine and observe the exact plunge depth.

WinPC-NC is able to measure the various lengths of tools automatically and compensate them during operation.



Parameters for tool length measurement are only available if the function is enabled.

Z-axis length

The lengths of the tools used are defined here. Normally, the boxes cannot be edited, however, the values are registered automatically when the tools are measured. The length difference used by the *compensation* function is calculated on the basis of these parameter values.

Sensor position

Automatic ascertainmemt of length

The length sensor must be a switch or a button which can be moved from above and is switched when contact is made or is encountered.

These paramaters define a position above this sensor in absolute machine coordinates. When measuring, *WinPC-NC* moves to this positions and then lowers the tool slowly until the sensor is switched. The distance moved is adopted in the paramaters as tool length.

The slow manual speed for Z-axis is used while measuring.

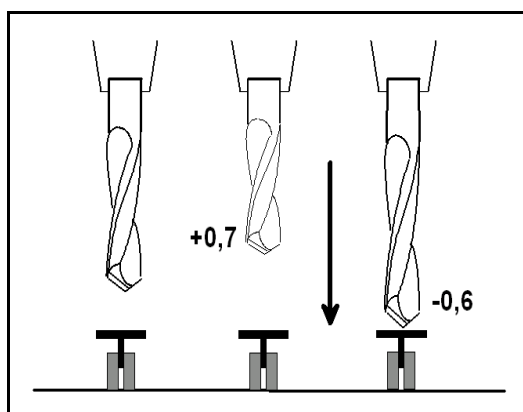

Diagram showing the basic principle of the length sensor and automatic tool measurement

Automatic length correction

This parameter activates automatic tool length compensation. Having a separate parameter to enable this function makes it possible to restrict compensation to projects in which it is really needed.



Tools are not automatically measured after being changed. Instead, this measurement must be explicitly selected using the MEASURE TOOL function before each tool is used.

Length check after tool changed

This parameter enables *WinPC-NC* to perform a tool length check after each tool change.

Fast move to sensor with brake

To speed up the process you can activate the two step measurement and force *WinPC-NC* to move to the sensor with fast manual speed, brake the movement, reject the tool over the sensor and do the measurement in a second step precisely.

4.2. Speeds

All the parameters which control the speeds of the motors are grouped together in the *Speeds* dialog box.

The optimum parameter values for the required speeds can be determined using the *MOTOR TEST* function.

All parameters must be set separately for X, Y and Z. This means the correct speed can always be calculated and used, even when different axis resolutions are involved.

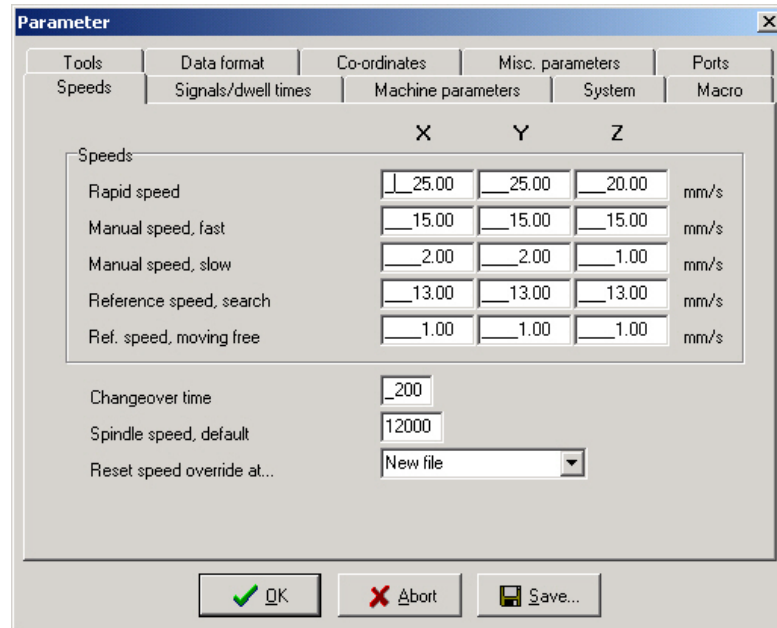

Speeds parameter

Rapid speed

Speed with the tool raised

Rapid speed is used for moving to a new position with the tool lifted out of the workpiece.

These are unproductive movements which **WinPC-NC** always moves at the fastest possible speed.

Jog speeds

These parameters specify the speeds during jog mode. Two speeds can be defined.

Individual steps or continuous movement

The motor changes over to continuous movement if the key or the mouse button is pressed for a longer time. It moves at the speeds defined here in this case.

It makes sense to use fast speed to traverse long distances, while exact positioning is facilitated with slow speed or single steps.

Reference speeds 1/2

In reference movement, each axis starts moving at speed 1 and searches for the reference switch.

The axis is braked when the switch changes the level, at which point the axis moves in the opposite direction away from the switch at speed 2.

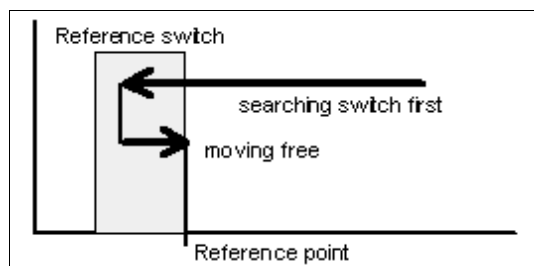

Reference movement of an axis

Reference point of the machine

The edge of the reference switch defines the absolute machine zero point or reference point for this axis. A low value should be specified for speed 2 so the movement ends with the shortest possible ramp when moving free.



WinPC-NC distinguishes between machine coordinates (with the reference position as their origin) and workpiece coordinates with the workpiece zero point.

Changeover time

The changeover time defines the delay for the transition from single step to continuous movement in *jog mode*.

WinPC-NC outputs individual steps to the motors every time one of the cursor keys is pressed briefly or the mouse button is used to click one of the movement buttons once. If one key or button remains pressed for a longer time, that is the changeover time, the motor changes to continuous movement and is not stopped until the key or button is released.

Standard spindle speed

The standard spindle speed is always used unless another setting is made specifically in the NC program or in the tool parameters. Usually this is the case when starting the spindle in jog movement or working process.

Reset override speed

The feed and spindle rate are permanently changeable while **WinPC-NC** is processing a job. This parameter stipulates how long this alteration is activated.

Following settings are possible :

Machine reset or program reset	Only with restarting <i>WinPC-NC</i> it is possible to place back the override values to 100%
New file	Values are placed back by loading a new NC file
Job start	Reset of the values is made by the following start of an job process.

4.3. Coordinates

In the *Coordinates* dialog box it is possible to define all parameters relating to dimensions, help points and the unit of measurement.

The screenshot shows the 'Parameter' dialog box with the 'Co-ordinates' tab selected. The dialog is organized into a grid with columns for X, Y, and Z coordinates. The rows include 'Working piece from', 'to', 'Zero point', 'Park position', 'Scaling factors', and 'Toolift'. Each row has three input fields for X, Y, and Z, followed by a unit indicator 'mm'. Below the grid, there is a 'Unit of measurement in I' dropdown set to '1/1000 mm', a checked 'Work piece area monitoring' checkbox, a 'Units' dropdown set to 'mm + mm/s', and a 'Surface block' text field containing '-23.10 mm'. At the bottom, there are buttons for 'OK', 'Abort', 'Save...', 'Circular/Cutting', 'Measure', and 'Massprod'.

Setting the working area and the help positions

Additional parameters can be obtained by means of further buttons, e.g. admittance of a repetition function, activation and parameter setting of tangential cuts or circular engravings.

Machine and workpiece coordinates

It is necessary to distinguish between two types of position definitions. There are absolute machine coordinates with their zero point at the machine reference point. Then there are workpiece coordinates with their origin at the workpiece zero point.

Working area and monitoring working area

Software area monitoring The working area defines the section, e. g. for marking material dimensions. Limits are visible in the graphical display and it is immediately recognizable whether milling or engraving can be effected with the material piece. A check is made when job starts.

Maximum plunge depth for Z-axis The working area for the Z-axis determines the maximum plunge depth to which tools can move without damaging the bed of the machine.

These parameters are not to be mixed up with the values determining the size of the machine table and thereby the maximum moving area.

The unit is millimeters and the distances are measured from the machine reference point (machine coordinates).

Zero point

The zero point refers to the reference point of the coordinates in the working file. It is the position with a specific X and Y-axis coordinate within the NC file, e.g. the left-hand bottom corner. All processing distances are measured from here.

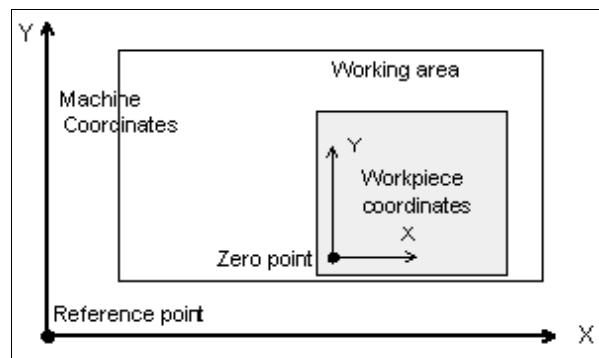

Working area and help positions

Zero point as origin of the workpiece coordinates

The zero point can also be defined manually. To do this, it is necessary to move to the required position using jog movement and then save this as the new zero point. The positions of the axes can also be saved individually.

The unit is millimeters and the lengths represent the absolute distance from the machine reference point (machine coordinates).

Park position

Defined position for breaks It is necessary to define a park position if the machine slide is to be moved out of the working area at certain times. This may be necessary for a tool change, for example, or for clamping the workpiece.

It is also possible to make this definition during jog movement by moving into position with the keyboard or mouse.

The parked position can be moved to in jog movement or automatically during a tool change and at the end of a working process.

The unit is millimeters and the distances are measured from the machine reference point (machine coordinates).

Scaling factors

It is possible to compensate for calibration differences using the scaling factors. If both the axis resolution and the unit of measurement are set correctly but the machine does not move to the exact length nevertheless, this problem can be corrected using the scaling factors.

The values must be specified to 3 decimal places and are used for multiplying the coordinate values to which the machine is to move. It affects the imported NC data only.

Tool lift

Additional clearance for avoiding collisions It is possible to define an additional height above the zero point level of the Z-axis as a safety clearance. The tool is lifted above the zero point by this distance during every unproductive movement with rapid speed and the new height is used as tool lift height.

On the next plunge movement, *WinPC-NC* first covers the safety clearance down to the zero point at high speed, before pressing into the material with the defined plunge speed.

Unit of measurement

Wide range of predefined units of measurement The unit of measurement for working data must be defined using this parameter. All coordinate values in the working file are related to a particular dimension.

The possible units are millimeters and inches. HPGL files are usually in units of 1/40 mm or 1 mil, while drilling data are usually in 1/100 mm or also 1 mil. EPS and AI files are in 1/72 inch.

Units in the program

The *UNITS* parameter defines the units for dimensions and speeds used in the graphical display and the parameters.

It is possible to select between three options :

- Millimeters and millimeter/second (mm and mm/s)
- Millimeters and millimeter/minute (mm and mm/min)
- Inch and inches/minute (inch and inch/min)

Sensor dimension

*Measuring
Z-axis heights
automatically*

WinPC-NC can automatically measure different Z-axis heights using a sensor block (surface block). The sensor block outputs a signal when it is contacted from above, and the signal is processed as an input at the LPT port.

The measuring procedure involves several steps:

1. Place the sensor block on the workpiece surface or on the machine bed for the maximum Z-axis depth.
2. Move the tool over the sensor block in jog mode.
3. Start the measurement using the MOVE-JOG menu function.
4. *WinPC-NC* slowly moves the tool down to the sensor and stops when it makes contact. The position is checked and added to the defined sensor dimension, the result being stored as a parameter.

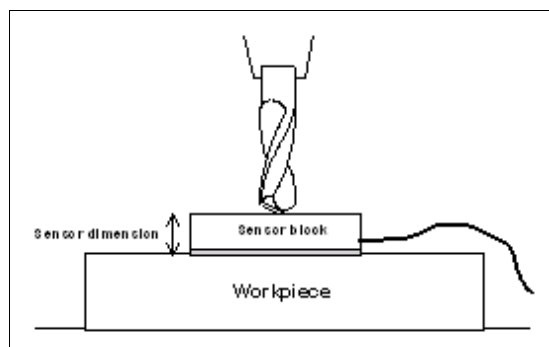

Automatic measurement of the Z-axis zero point

Mass production function

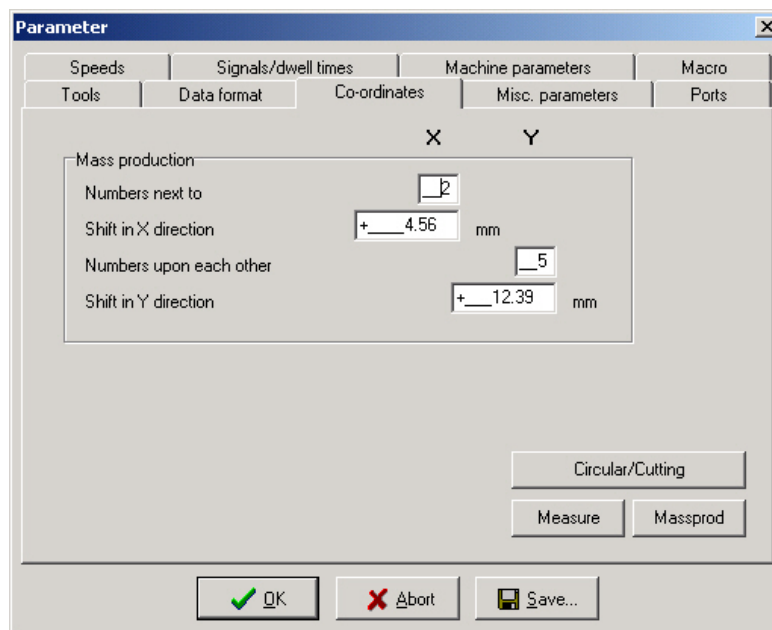

Parameter for mass production

Number of pices next to and apou each other

These paramaters determine the numbers of pieces in rows apou and in column next to each other.

Offset zero points

This paramater defines the distance between the working pieces. The offset has to be slightly greater than the dimensions of the pieces.

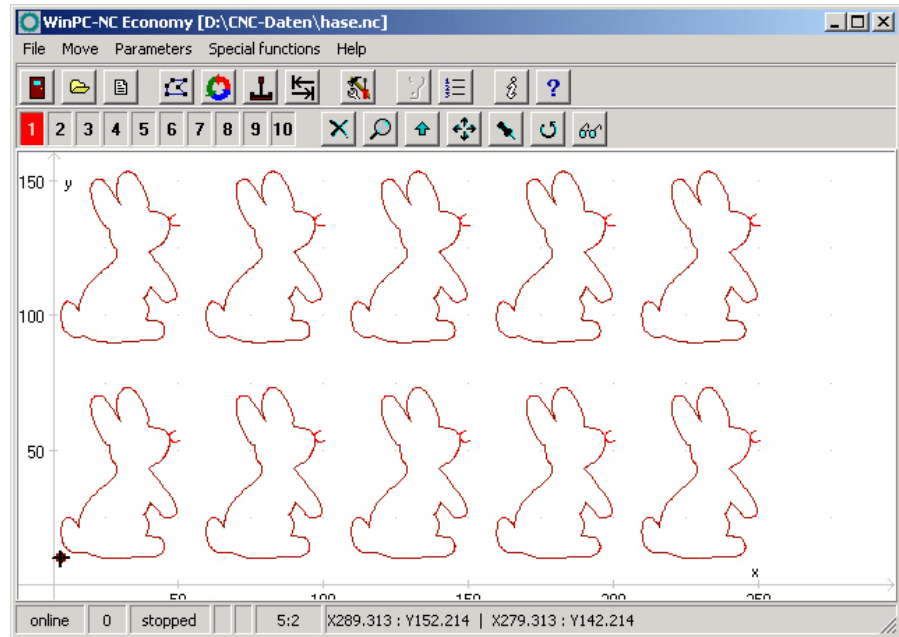

Mass production with 5 times 2 parts

Circular engraving

Engraving on cylindrical bodies

By means of the 4th axis **WinPC-NC** is able to create round engraving on a cylindric body. Any Y-coordinate of the engraving data is calculated by means of the defined diameter and are moved by rotation of the 4th axis.

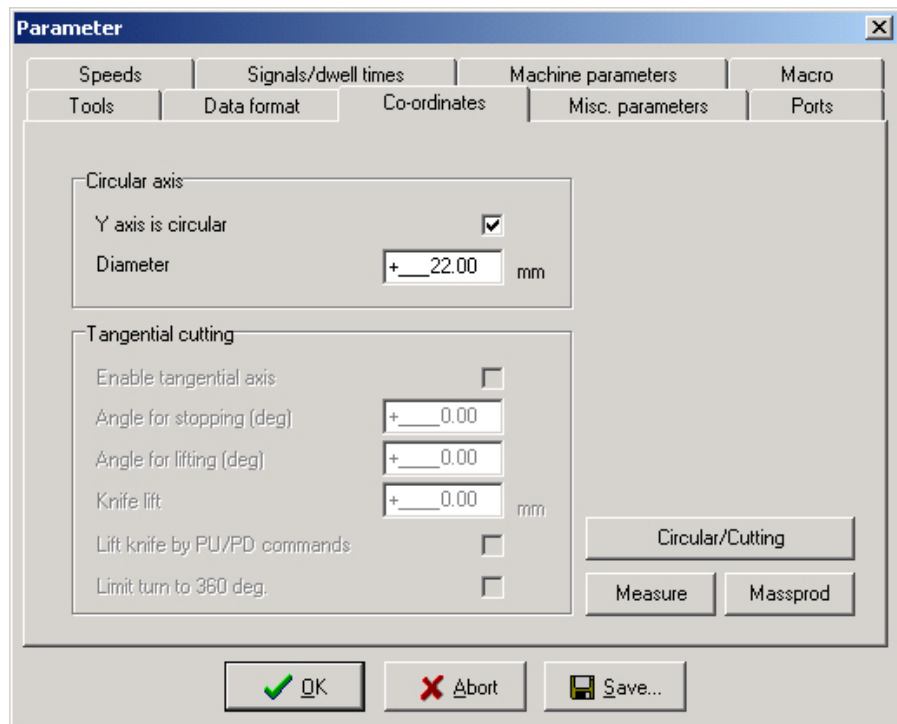

Parameter of circular engraving

Y-axis is circular

This parameter generally switches on or off the function for circular engraving.

Diameter

The diameter of the cylindric body is essential for executing calculation of the Y-coordinates and should be entered with greatest exactness.



Round engraving is only possible with data in HPGL format.



Sample of circular engraving

Tangential cutting

An existing 4th axis can also be actuated by *WinPC-NC* as tangential axis for cutting tasks, e. g. sheet cutting. Rotation will automatically effected in move direction.

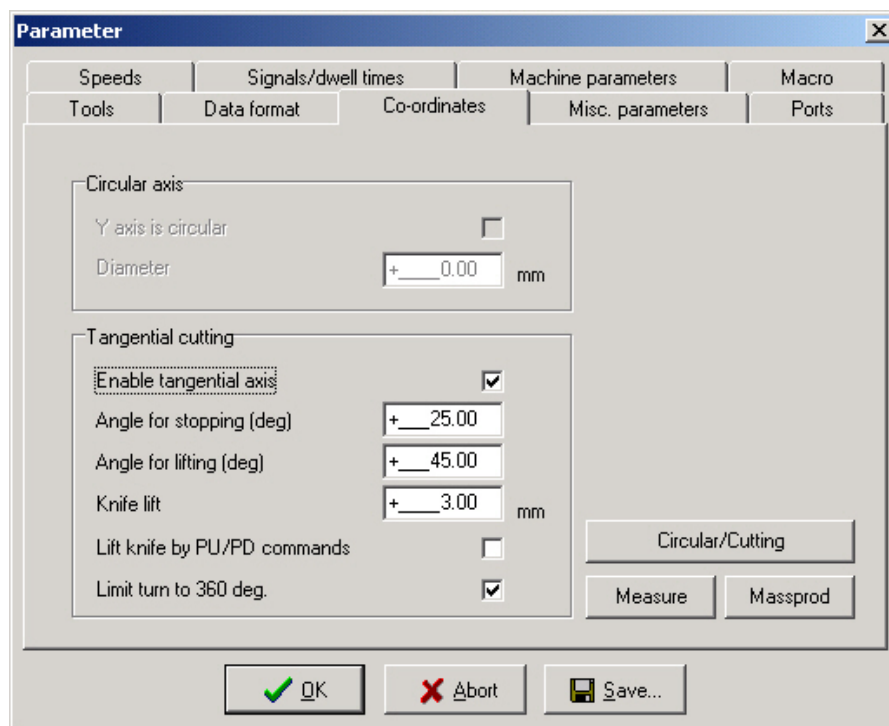

Parameter for tangential cutting

Enable tangential axis

The parameter *Enable tangential axis* is generally responsible for switching on or off the tangential axis function. If it is activated this function will also be considered during reference move.



Tangential cuts are only possible if the 4th axis is equipped with a defined reference switch or if a reference move has been carried out. Otherwise the user is asked to execute a reference move.

Angle for stop, lift an lift height

During the process of tangential cutting it is important to avoid too large or too wide cutter rotations into the material. By means of both angle parameters it is possible to determine exactly the moment of stopping a movement concerning direction change or cutter rotations or even when the cutter has to be lifted.

External cutter rotations

A movement will be previously stopped when the cutter rotations are greater than the stop angle, then the cutter will be rotated and subsequently the movement will be continued. If rotations are greater than the lifting angle the cutter will be lifted after a movement stop and then it is rotated and put down again.

With the parameter *knife lift* you can determine the height in millimeters, in which the cutter is lifted prior to rotation. This should be setted in the way to avoid damages of the material to be cut.

Lift with PU/PD

Lifting the cutter during rotations is normally directly effected by the program. However, if macros are used which are working solely with *Lift* and *Lower* commands, lifting of the cutter can be forced by this parameter with PD and PU commands integrated in HPGL data.

This parameter is only applicable using macros.

Rotation of max. 360 degree

With certain tangential heads it is impossible to carry out rotations over 360 degree because there can be strokes or overstripped cables.

Limitation of cutter rotations

An activated parameter carries out rotations always within the limits of 0 to 360 degree. Movements requiring cutter rotations over this limit are stopped, the cutter will be resetted and then movement will be continued.



Sample for foil cutting with tangential axis

4.4. Data format and associated parameters

WinPC-NC can read and process various data formats. The format of the NC file can be selected manually or registered using an automatic recognition function.

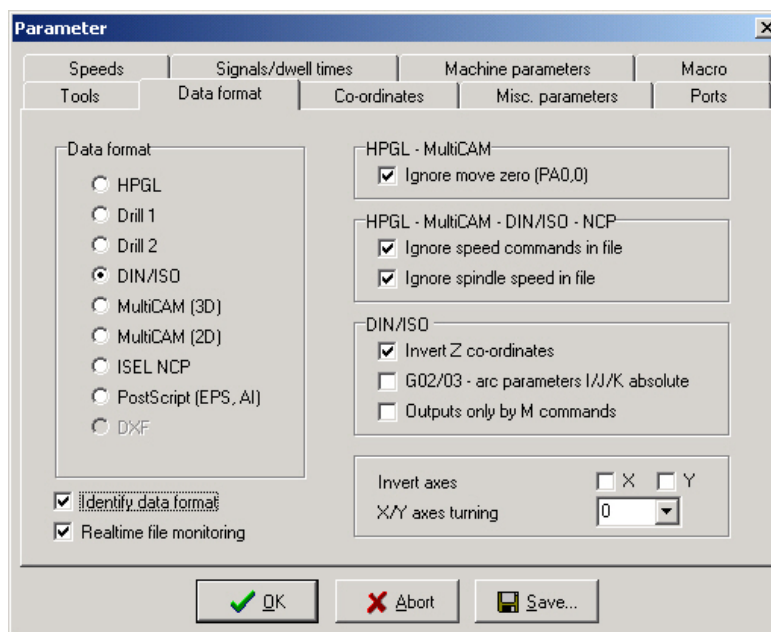

Data formats and associated parameters

Data format

WinPC-NC understands various NC data formats, and is able to import these files, display them and perform the movements on the machine. At present, the commonly used plotter format HPGL, MultiCAM, two drilling formats, G code (DIN/ISO) and ISEL NCP are possible. Furthermore *WinPC-NC* is able to recognize vector informations of postscript EPS and AI files, e. g. as created by various Adobe programs.

HPGL is from the well known plotters made by Hewlett Packard and is supported by almost every CAD or drawing program. MultiCAM (also referred to as Extended HPGL format) is very common in the USA and offers special 3D expansions for HPGL commands.

Plotting and drilling formats

The drilling formats are based on the following standards: Sieb&Maier1000, Sieb&Maier3000 and Excellon. In other words, it should be possible to process working files in these formats without any problems.

As a rule, industrial NC machines are programmed in the DIN/ISO format by G codes.

The appendix contains a list and description of commands in the individual formats. In the event of problems during processing, for example if unknown commands or commands which cannot be interpreted are encountered, then the working file can be analysed using this description and revised with the editor.



WinPC-NC usually recognizes the format of the selected file automatically.

Automatic identification of the format

Usually most of the supporting NC formats are automatically recognized by *WinPC-NC* during file opening. It rarely happens that errors are produced in this way. If it should be the case they can be easily eliminated by switching off the identification function and by manual adjustment of the correct format.

Ignore movement to zero (PA0,0)

It is a feature of HPGL and Multicam files that there is usually a PA0,0 command at the end of the program to move to the coordinate zero point. This can be suppressed using this parameter if it is not required.

Ignore feed rate and spindle speeds

HPGL, MultiCAM and G code formats also contain commands to set the spindle speed and the feed rate. Activate these checkboxes if you want to use the values set in the parameters rather than the commands in the NC file.

Invert Z-axis

Many CAD programs generate negative coordinates for plunge movements of the Z-axis. Activating this checkbox inverts the coordinates of the Z-axis so that these NC files can also be read in and processed correctly.

G02/G03 - I/J/K relative

There are various dialects of G code programs. In some, the circle parameters I/J/K are specified as absolute values, while in others they are relative distances from the current position. This parameter enables you to distinguish between the types.

Output signals with M commands

In G code programs, it is possible to switch almost all outputs such as the spindle, cooling, etc. using M commands. This parameter prevents *WinPC-NC* from operating a signal automatically and forces it to utilize exclusively the M commands which are used.

Otherwise, *WinPC-NC* would automatically switch on the spindle at the start of the process and switch the cooling on and off when lifting and lowering the tool.

Mirror axes

The X and Y-axes and their coordinates can be mirrored independently of one another for all formats. A changed parameter is immediately visible in the graphical display.

Rotation of X/Y axes

The NC data can be rotated around the zero point, e. g. for a better placement on the material. Rotation always happens in 90 degree steps.

File realtime display

It is possible to obtain a general view of the current program position during a job by a file display. This display shows in realtime the actual executed command by a cursor bar during operation.

The file display *realtime* applies to all formats, excepting postscript format and shows files of up to 32000 lines.

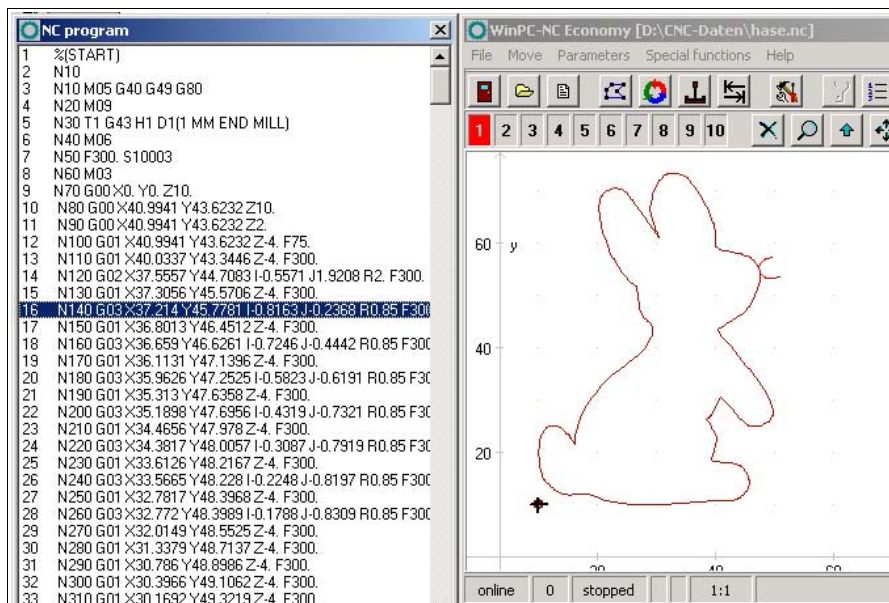

File display of realtime during a job

4.5. Miscellaneous parameters

The miscellaneous parameters include various switches and other settings which are not assigned to any other group.

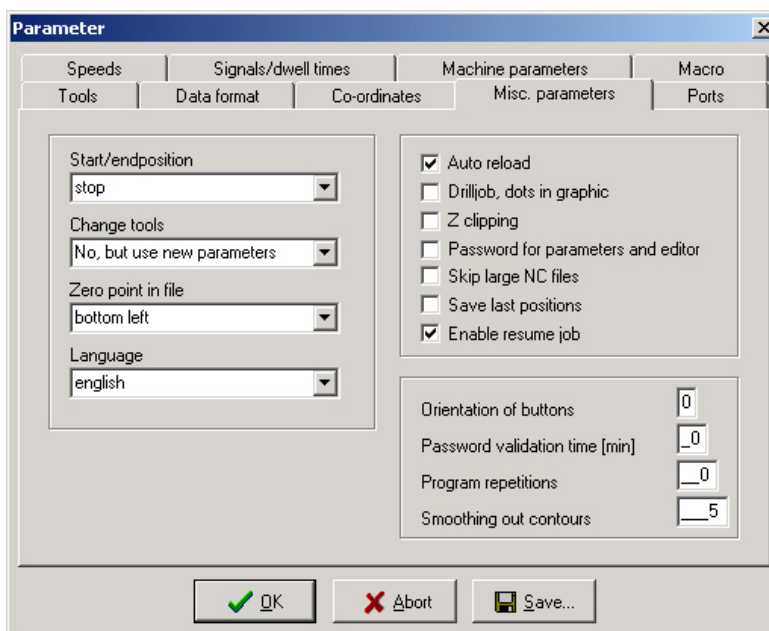

Miscellaneous parameters

Start and end position

This switch specifies where the start and end point of each working process should be located. The machine also moves to the position after reference movement.

There are 3 possible start and end positions :

Stop	<i>WinPC-NC</i> stops at the reference position after reference movement, and at the last coordinate after each job process
Zero point	The machine moves to the defined zero point after reference movement and after each job process.
Park position	<i>WinPC-NC</i> moves to the defined parked position after reference movement and after each job process.

It is a good idea to move to a certain position after the working process if space is required in order to change the workpiece.

Tool change

The parameter defines how *WinPC-NC* handles the tool change commands during a working process.

There are 4 possibilities for the tool change :

NO	No tool change is performed, the entire working process takes place with the current tool
YES	Performs the tool change and remains stopped in the current position for every tool change
YES at park position	Performs the tool change and moves to the defined park position for every tool change
NO but use new values	No tool change is performed, although the values for plunge depth, plunge speed and feed speed of the new tool are adopted.

Zero point in file

The workpiece zero point is the point in the NC file which has its position defined in the coordinate parameters. However, it can be located at various points inside or outside the workpiece and these points are defined here.

3 positions are possible :

Bottom left	The zero point is at the smallest X and Y-axis coordinates in the file, normally at the bottom left edge. Mostly used with HPGL files.
--------------------	--

Origin of Coordinates	The zero point is at the coordinate origin, i.e. where the CAD programs places it for the output. N This setting is to be recommended if several files are being used on the same workpiece, e.g. routing and drilling a board or when using G code files.
Center	The zero point is in the middle of the workpiece, i.e. exactly in the center of the coordinate dimensions in the X and Y-axis directions. This setting is useful for processing round workpieces, e.g. plates.

Language

WinPC-NC is multilingual. The standard version already includes a few languages, and additional languages can easily be bolted on if required. The available languages are listed in a menu.

According to the status of June 2006 following languages are available: german, english, french, spanish, portuguese, italian, turkish and polish.



The language changeover takes place as soon as you select a new language and click *Save*.

Automatic reload

The *reload* function continuously monitors the date and time of the currently loaded file and reloads the newly modified file if there is a discrepancy.

Using this function, for example, it is possible to edit an NC file in the drawing program, make continuous changes to it and then, when you switch back to *WinPC-NC*, to be able to check all the changes on the screen straight away.

Drill job, dots in graphic

*Marking
insertion
points*

The graphical display does not show holes drilled with HPGL, MultiCAM or G code formats. Activating this parameter marks all insertion points with a small circle.

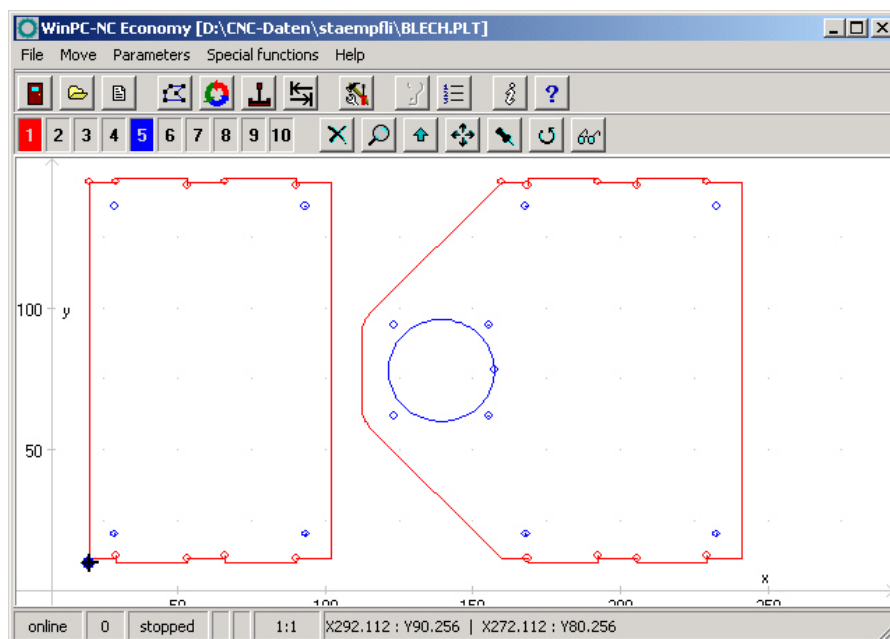

Display as drilling job with marks showing insertion points

Z-axis clipping

When the Z-axis clipping function is activated, *WinPC-NC* monitors the maximum Z-axis depth and cuts off all deeper movements at the working area limit.

Password and period of validity

This parameter activates a password which must be entered prior to change the parameters or a loaded program. The password is fixed.

The period of validity stipulates the term how long the password is valid and how long it is not interrogated again.

Skip large NC files

Faster display

The analysis function and graphical display may take an extremely long time with very large NC files. This process can be speeded up by only reading in and displaying the first parts of the file. In such a case, a large cross is superimposed on the graphic display to indicate that not all of the file is visible.

The following functions are not available in this partial view: Zoom, shift and set position.

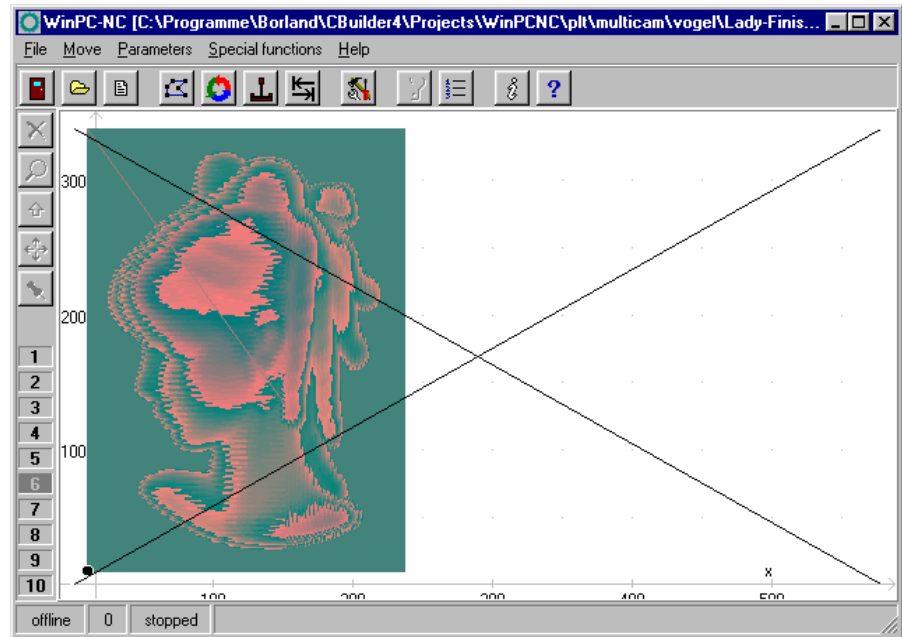

Partial display of a file with marking

Save last positions

WinPC-NC can save the current machine position after each movement and job. This is meaningful if the machine works without reference switches or if it is not always possible to carry out a reference movement.

The position values remain unchanged even after exiting or restarting the program.

Enable resume job

WinPC-NC can continue operation of an interrupted job exactly at the interruption point. However, this function has to be enabled by a parameter.

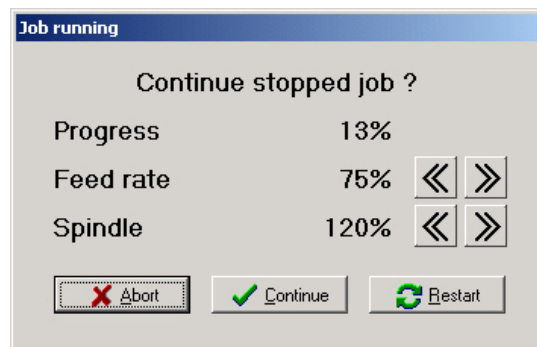

Interrogation at a restart or continuation of an interrupted job

Button orientation

Adapting the movement direction of the buttons

It is possible to use 4 settings to rotate the X and Y-axis directions through 90 degrees at a time in order to adapt the orientation of the movement buttons in *jog mode* to take account of the machine orientation.

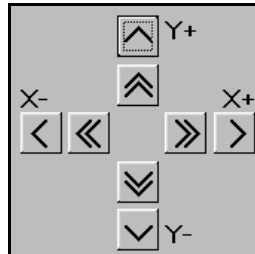

Button orientation position 0

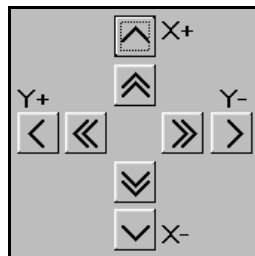

Button orientation position 1

Positions 2 and 3 turn the X and Y buttons through further 90 degree steps.

Program repetitions

The program repetitions parameter enables you to repeat a working process up to 999 times. This enables series production to be achieved in conjunction with a start signal.

Smoothing contours

Filter for producing finer contours

WinPC-NC is equipped with a filter in order to smooth contours and sheets consisting of many small vectors. This is necessary for producing fine and neat edges.

The parameter defines a factor of 0-2000.

4.6. Ports

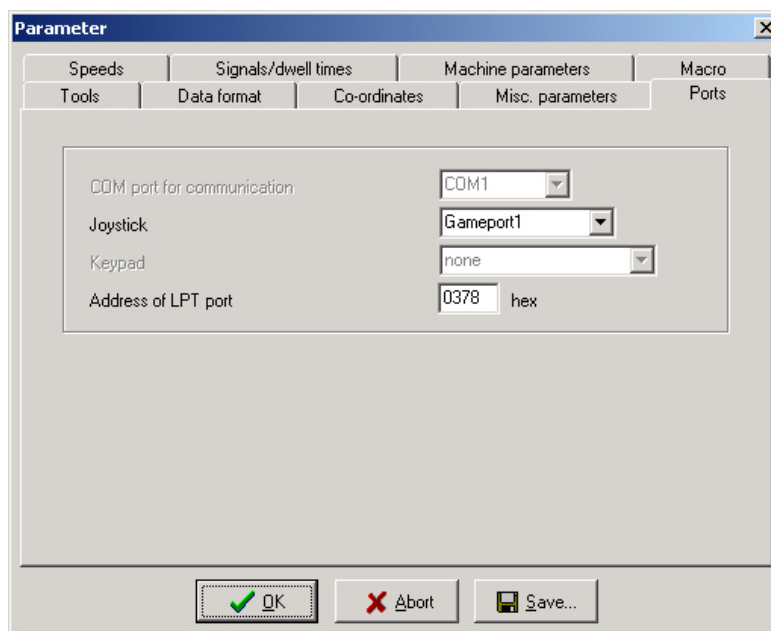

Port parameters

Joystick

If you want to use a joystick to set up the machine, you must use this parameter to define the game port used.



A connected joystick must be configured in the Windows system prior to use and must be calibrated with a special function.

Address of LPT port

Address of the LPT port

WinPC-NC Economy actuates a connected machine directly by the existing printer port without requirement for additional hardware. However, it is not possible to identify the address of the port automatically. This information can be learned from the device manager in the windows operating system.

Please execute the following steps:

- open the device manager under My Computer, system control, hardware
- open the category *connections COM and LPT* and select the LPT port which is connected to the machine

- select with the right mouse button the function *properties* and then *resources*
- note the port address under which the LPT port is integrated into the system. For internal ports the port address usually is 0378hex.

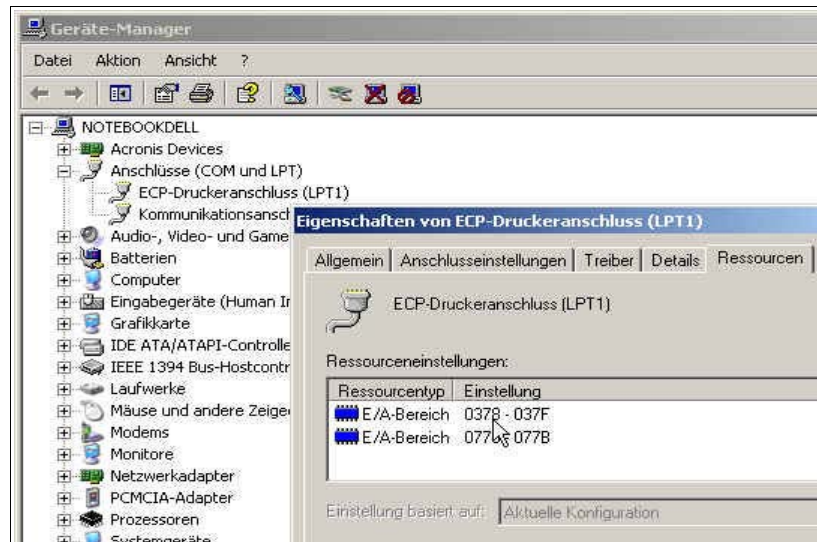

Identification of the LPT port address by the device manager

The detected port address has to be registered in *Win PC-NC* under *parameter-ports-address of LPT-port*. The procedure is finished by clicking *Save* and *OK*.



When the program is delivered the LPT port address is registered with 0378hex by default.

Further signals and inputs can be activated by *WinPC-NC Economy* with a second LPT port. Detailed information is given below.

4.7. Signals and dwell times

All input signals and associated parameters are grouped in a separate dialog box.

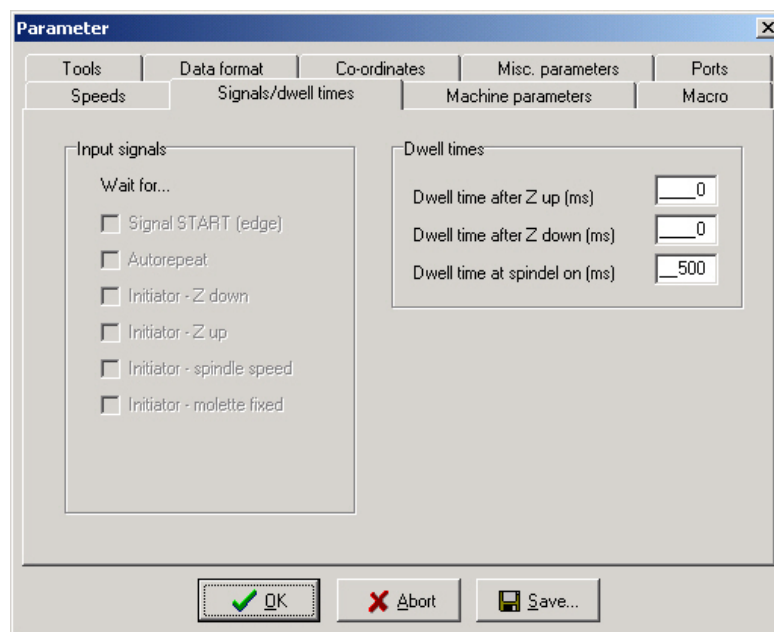

Signal parameters

Input signals

Synchronization with various sensor signals

WinPC-NC can synchronize the job sequence with various input signals. The option of activating these signals depends on definition and assignment of the signal transmissions and inputs.

The various signals and what they mean :

Start signal Following activation of the job process, **WinPC-NC** waits always for a positive edge on this signal and does not start processing the NC data until the signal changes from *LOW* to *HIGH*.

Sensor Z down **WinPC-NC** can wait for this signal after the Z-axis is lowered. The movements are not continued until the signal is active. This signal is particularly useful with pneumatic Z-axes.

Sensor Z up **WinPC-NC** can wait for this signal after the Z-axis is raised. Movements to the next insertion point are not continued until the signal is active.

Spindle speed It is possible to use this signal after the drilling spindle starts to indicate when the required speed has been reached. **WinPC-NC** waits until this signal goes to *HIGH* before continuing the process.

Clamping This signal can be used to indicate when the workpiece clamping is activated. The working process cannot be started until this signal is active.

Automatic repeat

*Perform
the process
repeatedly*

When the start signal is active, it is possible to use this parameter to make *WinPC-NC* wait for the next start signal as soon as it finishes a working process. This means no input from the keyboard or mouse is required.

Dwell time after Z up and Z down

In many applications, it is a good idea or indeed a requirement to wait a moment after the tool has been lowered or raised, before starting X and Y-axis movements. This may be the case when working with flexible materials or if you want the tool to freewheel.

The waiting time is defined in milliseconds.

Spindle acceleration time

*Acceleration
time for drilling
spindle*

The start delay defines a waiting time in milliseconds which always counts down when the additional *Drilling spindle* output signal is activated.

This ensures that the drilling spindle has enough time to accelerate before it is used for the first time.

4.8. Maschine parameters

Machine-specific parameters include all settings which relate to the mechanical characteristics of the machine. Only some or even none of these parameters are present in certain OEM versions of *WinPC-NC*. Instead, the parameters will have already been set correctly in advance for the machine in question.



Always take the greatest possible care when setting or modifying any machine-specific parameters, in order to avoid machine defects.

For a better view the machine parameters are grouped in further windows which can be displayed by clicking the corresponding buttons.

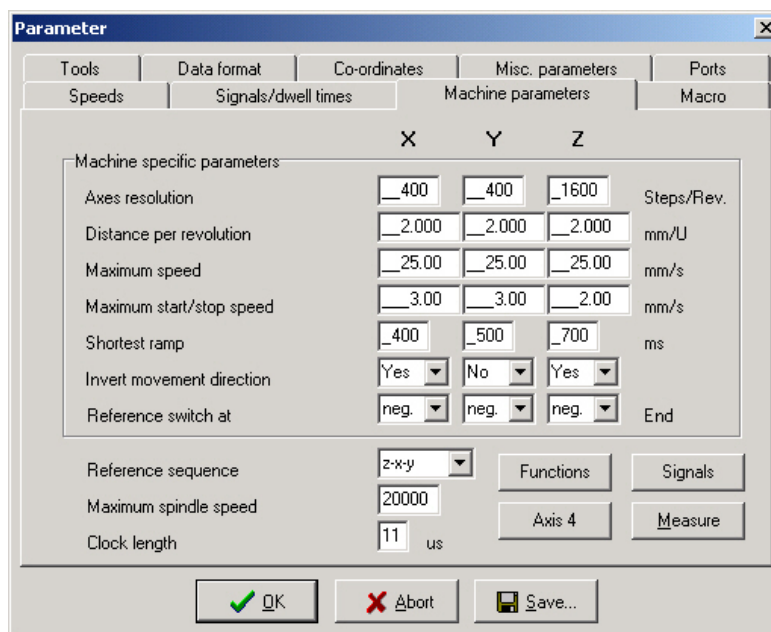

Machine-specific parameters

Axis resolution

The resolution boxes define the number of motorsteps per rotation. If you are using gear units or step down/step up ratios, you can enter the calculated values here directly.

The unit is steps.

Distance per rotation

You have to use this parameter to define what distance is moved during one motor rotation. Defining the axis resolution with two parameters offers the advantage that no calculation inaccuracies can arise.

The unit is millimeters with decimal places.

Maximum speed

You should use the *MOTOR TEST* function to ascertain the maximum speed of each axis. This represents the absolute top limit speed with which the axis can be moved.

WinPC-NC monitors the speed entries made in all other parameter windows and always corrects them to the value defined here.

The unit is millimeters with decimal places.

Maximum start/stop speed

The start/stop speed specifies the fastest possible speed with which the stepper motors can start up without ramps. The value is important for calculating path control, because braking at sharp edges or corners does not have to be to a standstill, but only down to this start/stop speed.

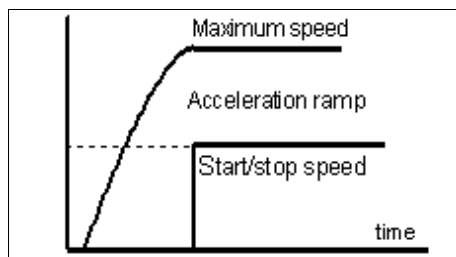

Start/stop speed and ramps

The optimum value can be ascertained with tests, e. g. by the function *MOTOR TEST*. Therefore it is necessary to switch off the ramp and accelerate the speed until step losses are caused. The value, detected in this way, should be reduced by 30% as a precaution.

Shortest ramp

The *ramp* parameter specifies the length of the acceleration ramp until maximum speed is reached, or the deceleration ramp from maximum speed to stationary, in milliseconds.

Individually adjustable ramp length

During each movement, the speed is increased until the maximum speed is reached. At the end of each motor movement, the speed is slowly reduced until the motor ramp length comes to a stop.

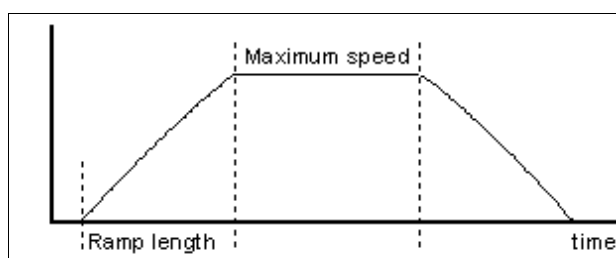

Speed profile of a motor movement

Accelerating and braking with ramps prevents step losses of the motors and allows faster maximum speeds. The gradient of the ramp remains unchanged in all movements, i.e. the ramp time is shorter for movements at slower speed.

Invert movement direction

There are two possible remedies if one of the motors is moving in the wrong direction.

Changing over the movement direction

Either swap over the motor winding connections or change the movement direction with this parameter. The direction signal for controlling the motor is then inverted before being output.

Reference switch

This parameter enables you to define in which direction the axis is moved in order to search for the switch. Movement clear from the switch then takes place in the opposite direction.

Reference sequence

Reference movement of the individual axes takes place in a particular sequence. Usually, it is necessary to move the Z-axis upwards first so it is withdrawn from the workpiece. Then the two other axes move to their reference points.

Possible faults with reference movement

After the machine is started up for the first time, there may be faults with reference movement which can be remedied as follows:

- Axis moves in the wrong direction
Remedy : **Define that the reference switch is at the other end of the axis.**
- Axis moves in the correct direction, but stops after reaching the switch and does not move clear again
Remedy : **Define the reference switch at the other end and change the switch logic.**

Maximum spindle speed

Speed control in 256 steps

WinPC-NC can control the speed of a drilling or milling spindle. It is possible to define a speed for each tool, or the speed data is taken from the NC files.

The maximum value defines the reference for step 256. All lower values are calculated proportionately between 0 and this value, and are output.

The spindle speed is generated from *WinPC-NC Economy* on the data byte (pin 2-9) of the second LPT port.

Clocking pulse length

Signal-timing

Controlling stepper motor drives is usually executed by brief clocking impulses. The pulse duration is susceptible by this parameter and they are always generated for at least 10µsec.

These impulses may be too short to be recognized by the electronics when using specific input filters or opto-couplers. Therefore you have the possibility to prolong this time by parameter. However, it has to be considered that longer pulse duration may affect calculation performance and therefore should be avoided.



If you really have to set the clocking pulse duration, please select the smallest possible value in order to guarantee a steady and constant run of your axes.

Using the SMC version and SMC stepper motor cards the clock pulse duration is without any impact.

Parameters to machine sizes

The screenshot shows a 'Parameter' dialog box with several tabs: Tools, Data format, Co-ordinates, Misc. parameters, Ports, Speeds, Signals/dwell times, Machine parameters, and Macro. The 'Machine parameters' tab is active, showing a table of parameters for X, Y, and Z axes. Below the table are three checkboxes: 'Machine area monitoring' (checked), 'Mallette closed by default' (unchecked), and 'Check ref. switches at reference start' (unchecked). There are also buttons for 'Functions', 'Signals', 'Axis 4', and 'Axes XYZ'. At the bottom are 'OK', 'Abort', and 'Save...' buttons.

	X	Y	Z	
Machine size from	+__0.00	+__0.00	+__0.00	mm
to	+_600.00	+_300.00	+_120.00	mm
Reference point is...	+__0.00	+_300.00	+__0.00	mm
Homing offset	+__1.00	+__1.00	+__1.00	mm
Backlash	__2	__3	__0	Steps

Second dialog box with machine-specific parameters

Machine bed dimensions and area monitoring

Machine size The effective movement area of the machine can be defined using these parameters. If area monitoring is activated, **WinPC-NC** checks and monitors these limits during subsequent movements, including jog movement.

A parameter activates or deactivates monitoring of this limits.

Reference point position

As a rule, the axes positions are reset at the reference switches during a reference move, i. e. the machine zero points are determined by the reference switches.

With some units it is advantageous to place the reference switches on the opposite side of the axes and not as usually on the negative end.

Reference positions individually definable With the parameter *reference point is* it is easy to instruct **Win-PC-NC** to set these specified positions on the reference switches and to place the machine zero point to a desired position.

Reference offset

Safe moving free of the reference switch To avoid a stop directly at the reference switch's edge after a reference and moving free it is possible to determine an additional path with the reference offset. This has to be carried out after moving free from the switch. First after moving the offset the axis is resetted or the defined reference position is adjusted.

Typical values are 0.5 to 1mm additional distances to the switch.

Backlash compensation

Drives which can not be adjusted absolutely close may cause insignificant differences during reversal of direction. These differences can be added up within the job process. This reversal drive can be compensated by these parameters.

Parameters for any axes are available in order to define the open circuit steps. The number of the motor steps are additionally indicated with any direction reversal.

Standard value means 0 steps und should remain unchanged if drives are closely adjusted.

Checking reference switches

*Reference move
exclusive with
vacant switches*

Prior to a reference move the parameter induces **WinPC-NC** to check the switches. Only if each defined switch is vacant a reference move can take place.

This test makes sense if several reference switches are connected on the LPT port by a single input line and if it is not possible for **WinPC-NC** to recognize the axis currently placed on its switch.

In case if the reference move should be rejected due to one or several actuated switches, it is necessary to move the switches free by the function *JOG*.

Settings of the 4th axis

Parameters of the 4th axis

WinPC-NC Economy is able to manage and process a 4th axis. Programming can be effected, for example, by a G code program. An other possibility is the automaic direction rotation of the tangential axis by **WinPC-NC**.



Prior to use the 4th axis has to be enabled. Otherwise the parameter settings are not available.

Some of the paramters as *speeds*, *inverting the dirrection* and *reference switch* are acting in the same way as for axes XYZ and not explained at this place.

Axis resolution/distance per rotation

The resolution parameters operate in the same way as the standard X, Y, Z axes. If you enter 360 or 36 as the distance per rotation, then you can program the 4th axis as a rotational axis in degrees or 1/10 of a degree.

Homing offset

The homing or reference offset defines the angle differential from the zero position after moving clear of the switch. **WinPC-NC** first looks for the switch at search speed and then moves back from the switch in the opposite direction. Following this, the reference offset is moved as a rotation round to the zero position.

*Adjusting
tangential
cutter*

Using the 4th axis as tangential axis the reference offset has to be adjusted in the way that the cutter edge shows in positive X direction after the reference move.

Axis 4 programmable as

*Letter for
programming*

The 4th axis can be addressed in G code programs using various axis letters. Axes parallel to X, Y, Z are normally designated U, V, W, while rotational axes in the X, Y, Z direction are programmed with A, B or C.

Homing sequence of 4th axis

The reference movement of the 4th axis can be performed either before or after the other axes.

Enable special functions

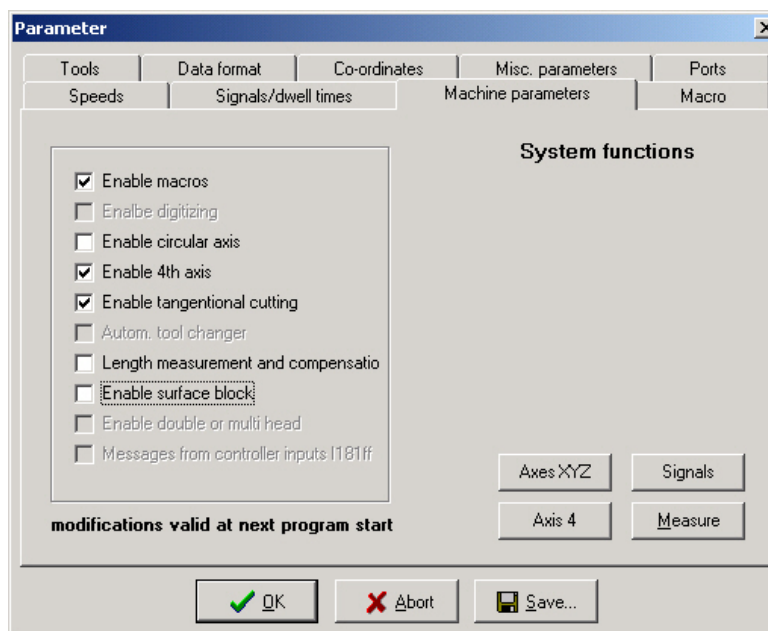

Enable or disable special functions in *WinPC-NC Economy*

There are some special functions in *WinPC-NC Economy* which are not activated by delivery. The enabling or disabling of these functions is possible with these parameters.



Enabling or disabling of special functions is only possible by restarting the program *WinPC-NC*.

Some of the functions are deactivated and only reserved to *WinPC-NC Professional*, others first can be activated after definition of special inputs or output signals.

The functions *tangential axis* and *round engraving* can only be used after activating an existing 4th axis. The functions *sensor block* and *length measurement* require in any case a sensor controllable by the Z axis and a definition of the corresponding input I221.

Signal wizard

*Userfriendly
adjustment of
the signals*

By means of the *signal wizard* a userfriendly adjustment and definition of all inputs and outputs is ensured. As this task is of great importance, you will receive detailed information concerning possibilities in a separat chapter.

4.9. Macros

The macros function in *WinPC-NC* offers you a powerful tool for individual adaptations to an extremely wide range of different mechanics and applications. User-definable macros enable the working sequence to be influenced and configured in many respects.



In order for macros to be used in *WinPC-NC*, they must be enabled as a specila function.

Flexibility with macros

WinPC-NC always stores defined macros in the WINPCNC.MAC file when the parameters are saved. They are always valid and apply to all projects. By clicking the *Reload* button, it is possible to load the most recently saved macros from the file again.

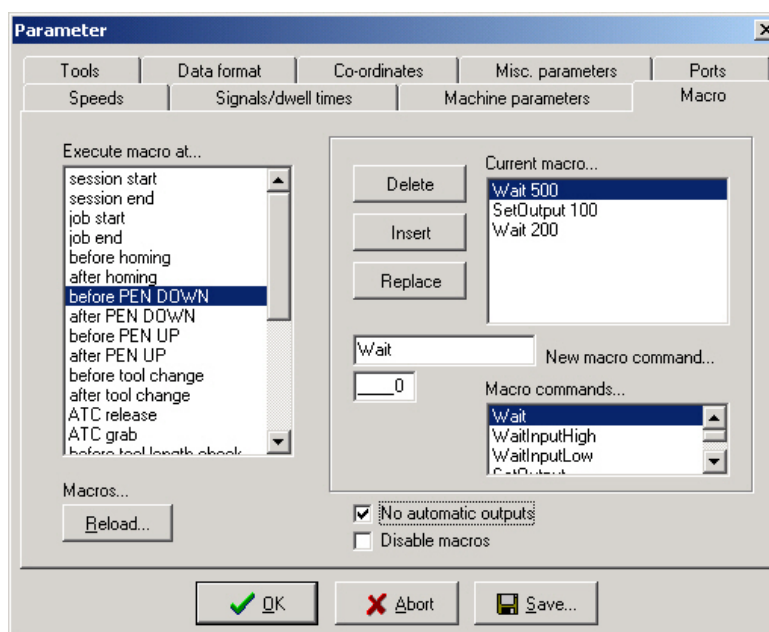

Macro definition

The dialog box for defining macros is divided into several parts :

- | | |
|------------------------------|---|
| left-hand list box | Possible points in the program when macros can be run |
| Top-right list box | Current macro, a new macro is assembled in this list box using macro commands |
| Bottom right list box | All possible macro commands which can be used to assemble macros |
| Editing boxes | Here, the selected macro commands are combined with the necessary parameter values, e.g. times in wait commands or distances in movement commands |

Editing buttons These allow the current macro command to be deleted, replaced or a new command can be added

Creating macros **Macros are defined in a procedure made up of several steps:**

- Select a program condition by double-clicking in the left-hand list box. This is the program condition for which the macro is to be defined. The top right list box then either displays an existing macro or *No macro defined*.
- Edit the required macro by double-clicking the lines you want to change to transfer them to the editing box. There, you can define different values for the commands. The new command is adopted when you click *Replace* or *Insert*.
- In order to create new or partial macros, you have to select the required command from the list box at the bottom right and then complete it in the editing boxes. Following this, the new command can be transferred into the current macro using *Replace* or *Insert*.
- To delete macro command, simply move the bar to the corresponding command in the current macro and click the *Delete* button.

Example 1
Release tool

Example for releasing a tool in the changer magazine:

Speed 80,00	Set the speed to 80 mm/s
MoveZ 156,34	Move down with the Z-axis
Speed 5,00	Set speed slower
WaitSpindleStop	Wait until spindle has stopped
MoveY 10,00	Move the tool into the chuck holder
MoletteOpen	Open the molette
Wait 500	Wait 500 ms for pneumatic system
Speed 2,00	Set very slow speed
MoveZ -5,00	Move 5 mm up from tool
Speed 80,00	Set speed back to fast
MoveZ -151,34	Move Z-axis all the way up
MoveY -10,00	Move Y-axis back to starting position

Example 2
Insertion when
flame cutting

Example of a macro defining an insertion procedure when flame cutting. It is always performed before *PenDown* commands.

MoveZ 50,00	Move down with the Z-axis
Wait 10000	Wait 10 seconds at pre-heating position 1
MoveZ 20,00	Move down again by 20 mm
Wait 2000	Wait 2 seconds and pre-heat
SetOutputHigh 100	switch on oxygen with output 100
Wait 500	Wait another 500 ms before movement



Please note that certain macro commands like *offset* or *macros* for certain additional functions, e. g. automatic tool changer, are only usable by *WinPC-NC Professional*.

Do not operate signals automatically

*Outputs
automatic or
with macros*

Normally, *WinPC-NC* operates a few output signals automatically. For example, the *Job in progress* output is set at the start of a working process and reset at the end or after a cancel. Equally, the following signals are also set automatically: *Drilling spindle*, *Coolant pump*, *Dispensing*, etc.

If it is better for the signals to be operated with the macros or if you want to change the times when they are operated, then you must switch off automatic operation with this parameter.

Following this, all signals can only be operated using macros.

Switching off macros

Using macros can be generally switched on or off by this parameter.

5. Initial start-up with the machine

Machine adjustment

After software installation on your PC it is necessary to carry out some start-up processes and corresponding adjustments.

This procedure is only necessary with the initial start-up procedure and generally relates to the adjustment of your machine. In case if you have acquired **WinPC-NC Economy** together with the machine either most of the parameters are correctly preadjusted or you have received an additional disk with the corresponding adjustments. If this is the case the following described procedure can be disregarded.

5.1. Connecting the machine

Connecting the machine is made on one or two LPT printer ports of the PC and the corresponding cables or adapters have to be used or manufactured.



Attention !

Greatest care has to be taken when connecting all cables to the housing. Following actions can cause serious damage: Incorrect assignment of the signal cable, plug incorrectly inserted, cables incorrectly connected.

Starting the entire unit is not allowed until all necessary and state specific safety rules have been accomplished and checked. The user is responsible for unit operation.



Attention !

For further interrogation of the status *emergency stop* or *ready for operation* it is essential to use one of the inputs. In this way it is possible for the control to stop actuation of output signals if necessary. Detailed information is provided in the documentation concerning controlling software. Please observe all instructions concerning machine safety.

Assignment and application of the possible input/output signals concerning the existing port pins is characterized in the following chapter. For an initial start-up, you do not require any signal input or, to simplify matters, you can use the predefined signals.



Please note !

The software *WinPC-NC Economy* is a controlling component only and used within a unit. In order to obtain a real working machine the software has to be completed by PC equipment, working appliance, drive systems and mechanics. The user is responsible for operation safety.

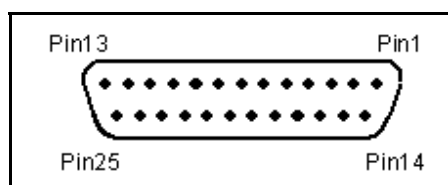

LPT port as 25 pole SUB-D-female connector

5.1.1. Pin assignment of clock/direction version:

*Pinning LPT 1
(clock/direction)*

**All signals on the LPT printer ports present 5V TTL level.
Pinning of the first LPT port is as follows:**

Pin 2	output	direction motor X
Pin 3	output	clock motor X
Pin 4	output	direction motor Y
Pin 5	output	clock motor Y
Pin 6	output	direction motor Z
Pin 7	output	clock motor Z
Pin 8	output	direction motor 4 (i.g.tangential axis)
Pin 9	output	clock motor 4 (i.g. tangential axis)
Pin 1	output	drilling spindle on/off (default)
Pin 14	output	coolant pump on/off (default)
Pin 16	output	current reduction (default)
Pin 17	output	job works (default)
Pin 10	input	reference switch X (default)
Pin 11	input	reference switch Y (default)
Pin 12	input	reference switch Z (default)
Pin 13	input	sensor/surface block (default)
Pin 15	input	vacant
Pin 18-25		signal mass (0V GND)

*Pinning LPT2***Pinning of the second optional LPT port is as follows:**

Pin 2-9 **output** analoqueous output, 256 degrees binary coded

Pin 1 **output** vacant

Pin 14 **output** vacant

Pin 16 **output** vacant

Pin 17 **output** vacant

Pin 10 **input** vacant

Pin 11 **input** vacant

Pin 12 **input** vacant

Pin 13 **input** vacant

Pin 15 **input** vacant

Pin 18-25 signal mass (0V GND)

*User definable
additional
in-/outputs*

All inputs on PINs 10, 11, 12, 13 and 15 as well as the additional PIN outputs 1, 14, 16 and 17 are free definable and assignable to the desired signals. When the software is delivered above mentioned signals are assigned.

5.1.2. Pinning of the SMC version:

SMC stepper motor cards are connected to the PC by a commonly used printing cable. SMC cards have all three reference switches connected to PIN 11 and there are no additional standarized inputs and outputs available.

*Pinning LPT1
(SMC)*

Pin assignment of the first LPT port as follows :

Pin 2 **Data1** 1+2 code of the current intensity phase A

Pin 3 **Data2** 11-no current 01-20% 10-60% 00-100%

Pin 4 **Data3** dircection of current phase A

Pin 5 **Data4** 4+5 code of the current intensity phase B

Pin 6 **Data5** 11-no current 01-20% 10-60% 00-100%

Pin 7 **Data6** direction of current phase B

Pin 8 **Data7** 7+8 code for motor X/Y/Z

Pin 9 **Data8** 00-X 10-Y 01-Z

Pin 1 **Strobe** adopting the signals

Pin 14 **output** coolant pump on/off (default)

Pin 16 **output** drilling spindle on/off (default)

Pin 17 **output** vacant

Pin 10	input	vacant
Pin 11	input	reference switch
Pin 12	input	vacant
Pin 13	input	vacant
Pin 15	input	vacant

Pin 18-25 signal mass (0V GND)

Port LPT2 is used analogously to clock/direction version and can liberally be assigned on the in- and outputs.

Further technical information concerning controlling SMC cards can be learned from documentation of the card. If the additional signals or vacant inputs of LPT1 are to be used by the machine, they have to be tapped directly on the cable.



Attention !

For safety reasons it is essential to use limit switches on all axes. In order to avoid accidents by contact during operation it is advisable to install a system for access control, e. g. a protective housing or a safety fence. Please connect these safety appliances with the controlling component and define the corresponding inputs.

5.2. Determination of axis resolution

For calculating the required distances and speeds it is necessary to tell *WinPC-NC* precisely the definition of the axis resolution.

Two parameters for avoiding calculation inaccuracies

Please open the parameter dialog box *parameter - machine* and determine the exact data of your mechanics and drives for each axis by the first two parameters.

The parameter *axis resolution* defines the number of steps or increments per rotation for the corresponding motor. Please consider the electronic settings relating to the macro/micro stepping operation and a possibly integrated reduction ratio.

Motorsteps and distance per rotation

The required value is the number of motorsteps *WinPC-NC* has to create in order to carry out exactly one rotation round the spindle or the shaft.

The second parameter *distance per rotation* defines the distance which is made exactly by the number of above mentioned motorsteps. With spindles it is the spindle rise or with belts or gear racks it is the graduated circle size of the pinion.



Incorrectly setted axis resolutions cause dimensional inaccuracies and inexact speeds.

5.3. Definition of LPT port

By the next step you have to define in *WinPC-NC Economy* the used LPT port respectively to determine its internal port address.

Ascertainment of LPT port adress

In order to ascertain the port address you have to activate the device manager in the system control. Please carry out the following actions:

1. Open the device manager under *My computer, system control, hardware*
2. Open the category *connections COM and LPT* and select the LPT port to which the machine is connected.
3. Click with the right mouse button to *properties* followed by *resources*
4. Note the port address under which the LPT port is integrated into the system. With onboard ports it is normally port address 0378hex
5. In case if an additional second LPT port is available in the system and you wish to make use of it with *WinPC-NC Economy*, you only have to repeat step 2 – 4

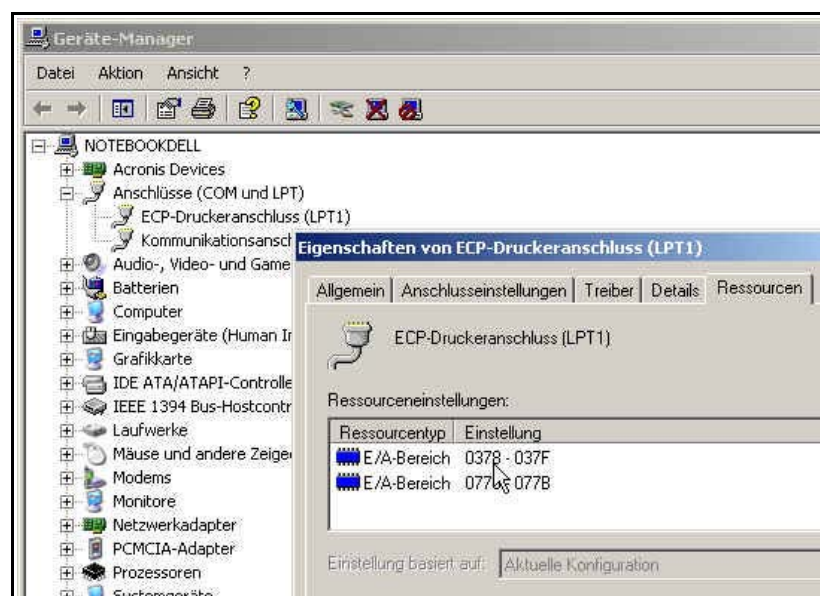

Identification of the LPT port address by the device manager

The detected port address has to be registered in **WinPC-NC** under *paramater machine-signals-port addresses* followed by clicking *Save* and *OK*.

After this process a simple test run with the function *JOG MOVE* or *MOTOR TEST* should be possible. Please act with the greatest possible care and be always aware of uncontrolled machine movements. If the axes do not move smooth or move at all, just increase the clock length parameter step by step.



When delivered the LPT port address is registered under 0378hex. This registration applies to most internal ports.

5.4. Determination of direction

Call the function *JOG MOVE* and move all axes with the cursor button or by mouse clicking to the arrow buttons and check machine direction.

Each button corresponds to a certain axis or direction . Please start with axis X.

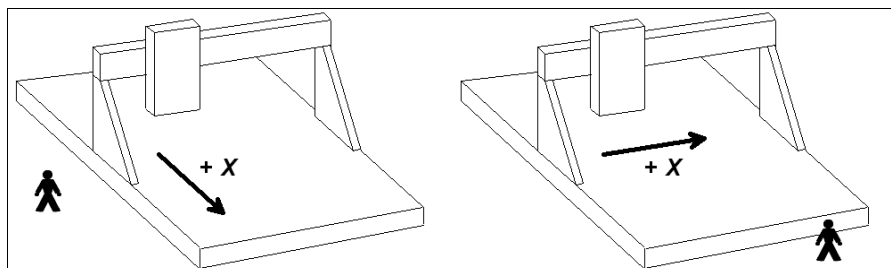
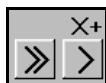

Arrow keys showing to the right side are to start a positive movement of the X-axis, i.e. following movement to the right of the machine.

Arrow keys showing to the left side are to move the machine left in opposite direction.

If this is not the case, one of the following errors may have occurred...

Error	Possible cause	Solution
Machine does not move	Incorrect port	Port adjustment
	Incorrect port pinning	Control of pinnings
	Maschine off	Check whether motors are energized and provide supply

Error	Possible cause	Solution
Movement of the wrong axis	Incorrect port pinning	Control and adjust the port pinnings
Axis X moves always in opposite direction, i.e. moves to the left by activated right-hand arrow and the other way round	Direction signal works with incorrect logic	Change the parameter <i>INVERT MOVE DIRECTION</i> under machine parameters

After checking the X-axis a further test of the both other axes is advisable. If necessary, please correct move direction by parameter.

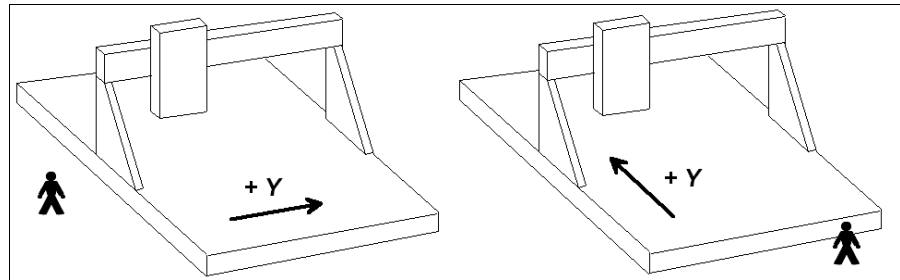
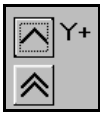

The machine has to move backwards when arrow keys showing to the top.

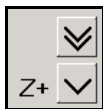

The Z-axis moves down when arrow keys showing downwards.

For a direction reversal of one axis it is only necessary to change the parameter *INVERT MOVE DIRECTION*.

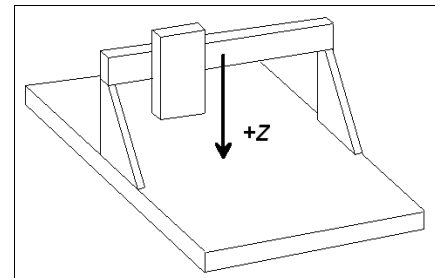

The move directions to be determined are always relating to the movement of the tool above the workpiece. Please pay attention to the correct setting of move directions by mechanics with moved table. The moved table runs always opposite to the arrow keys in order to guarantee a correct move direction of the tool above the workpiece.

5.5. Adjustment of the reference switches

The way of function of the limit and reference switches can easily be checked with the special function *SIGNAL TEST*. After activating this function a window appears with LED display for the most important inputs.

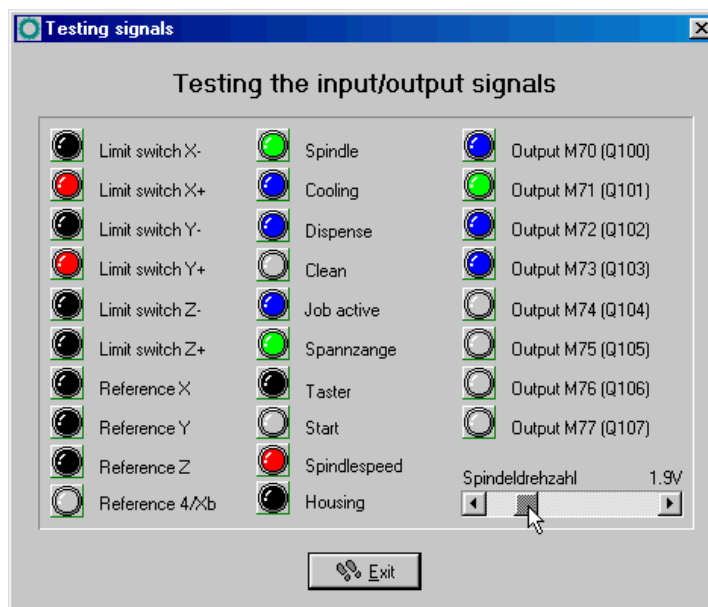

Special function *SIGNAL TEST* with LED displays of the most important inputs

Manual activating of the switch

After manual activating the switch of your machine please observe the reactions on the screen. Each change of switch must be clearly displayed. The LED flashes of the reference switch should change the color from black to red.

The definition of the reference switches has been correctly determined when the LED is black in unpressed condition and changes to red in pressed condition.

Depending on the used switch (NO contact – NC contact) the switching logic may be misapplied, i.e. red colored with the unpressed switch and black colored with the pressed switch. If this is the case, a change of the switching logic of the reference switch by parameter is required.

Determination of switching logic

Please carry out the following steps :

1. Open parameter dialog box *parameter-machine-signals*
2. Select the corresponding reference switch in left-hand window
3. Select the inverted entry in the drop-down menu below and accept the setting, e.g. change from **LPT1 PIN 10** to **LPT1 PIN10 INV**
4. Save the latest setting and recheck by function *SIGNAL TEST*

A detailed description of the signal wizzard and the possibilities for defining and setting the inputs and outputs is listed in the next chapter.

5.6. Sequence and direction of reference move

In the following step settings for reference move of the machine are stipulated. Please carry out the following steps:

1. Open parameter dialog box *parameter-machine*
2. Under *reference switch at pos./neg. end* you have to adjust on which axis side the switch is located. If it is not possible to be directly ascertained, change again to the function *JOG MOVE* and check by moving and observing the position counters and note to which position the axes move to in the moment when they are approaching the switch.
3. After the setting of all switches there is nothing else to do than selecting the *reference sequence*. The desired sequence can be stipulated in the drop-down menu. Normally it is always the Z-axis which starts moving upon to it's switch followed by the other axes.
4. If you intend a reference move of one or several axes into positive direction, it makes sense to place the machine zero point not at the switch but define another position by parameter.

5.7. Control of settings

After respecting all items a reference move with your machine should not cause any problems. Subsequent to the execution and saving of all parameter settings please press the function key (F8) or select the corresponding function by menu.

Reference move for control

During the reference move all axes run upwards to their switch according to the adjusted sequence and then downwards the switch with reduced speed. Exactly at the switching edge all axes are stopping and marking the reference point.

If this procedure should cause problems or stop with indicating error messages some of the settings have been incorrectly carried out. The tabulation below provides additional information concerning different kinds of errors and corresponding solutions.

Error	Solution
Axis moves into wrong direction	Define the reference switch at the other end
Axis moves into correct direction, but very slowly	Switching logic has been adjusted incorrectly and has to be inverted and define the reference switch at the other end
Axis moves slowly into correct direction, but stops on the switch	Switching logic has been adjusted incorrectly and has to be inverted and define the reference switch at the other end
Axis moves very slowly into wrong direction	Switching logic has been adjusted incorrectly and has to be inverted

5.8. Additional steps

The most important tasks have been finished by connecting the machine and setting the parameters. Additional actions are recommended in the following sequence :

1. Determination of the optimal ramps and speeds of all axes by the special function *MOTOR TEST*.
2. Determination of further speeds for *JOG MOVE* and *REFERENCE MOVE* by these values.
3. Desired functions can be enabled under *parameter-machine-functions*.
4. Connecting additional desired and required input and output signals definable by the signal wizard.

6. Signal wizzard

6.1. Using input and output signals

One of the most essential functions of *WinPC-NC* is the management of input and output signals.

Input and output signals

By means of inputs many useful functions have been implemented, e.g.

- Monitoring of the axes by limit switches
- Moving reference and thereby calibration of the axes
- Synchronization with various signals, e.g. *Start*
- Monitoring of the protection hood and safety fences

By means of output signals *WinPC-NC* is able to control various additional appliances or reconcile the process with other components. Examples for outputs are...

- Switching spindle and cooling
- Locking the protection hood during a job
- Switching the dispensing pump

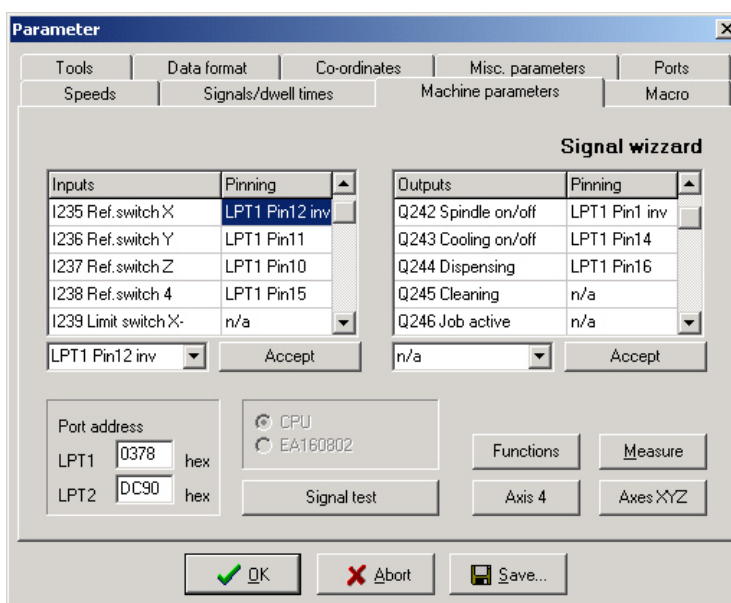

Signal wizzard

Integration of the signals

WinPC-NC is able to manage a lot of different signals, certainly all inputs and outputs are not required for each task. In this way it is quite simple to assign the required signals to the available supplies of the LPT printer port using the signal wizzard.

Each LPT printer port disposes of 5 input lines at the pins 10, 11, 12, 13 and 15 and 4 additional output lines at the pins 1, 14, 16 and 17.

You can connect the required signals at any possible pin. The assignment is subsequently effected by the signal wizzard which is activated by *parameter-machine-signals*.



Attention: Please take greatest care when assigning and testing the inputs and outputs. Be always aware of uncontrolled actions of the output signals.

Port address of the interface

Prior to assignment of the individual signals the LPT port address has to be checked and defined. Using a second port it is essential to enter also this address. These addresses are determined by the operating system and are indicated by the device manager, as described in the preceding chapter.

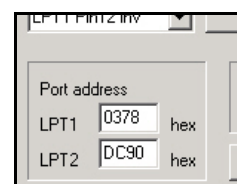

6.2. Assignment of inputs

Assignment of inputs

Please execute the following steps for assigning the input lines:

1. Connect the required switch or sensor to the available pin
2. First click to *Signal test* and observe the LEDs in the next window which are symbolizing the status of the individual input lines
3. Note or notice the pin number and the switching logic after manual pressing the individual switches. A normally open (NO) contact is characterized when the LED light changes from black to red during pressing. However, a normally closed (NC) contact is characterized when the LED light changes from red to black.

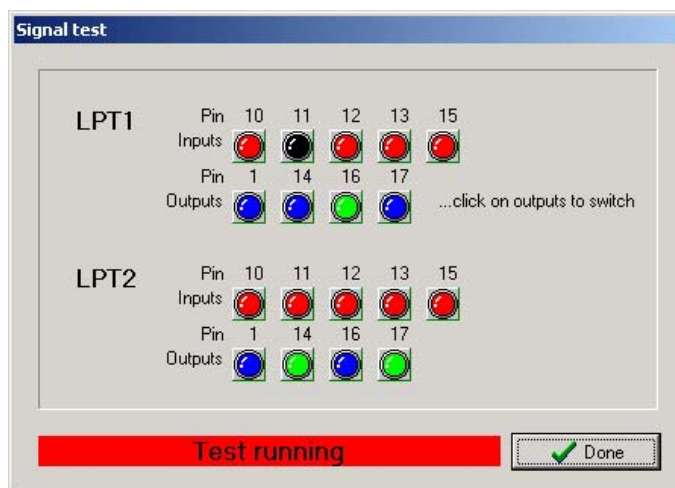

Interactive signal testing

- Click to the function *Done* and change again into the window of the signal wizzard. Select now the corresponding input signal in the lefthand window (e.g. I235 reference switch X) and open the drop-down menu below in order to assign the pin number (e.g. LPT1 Pin11).

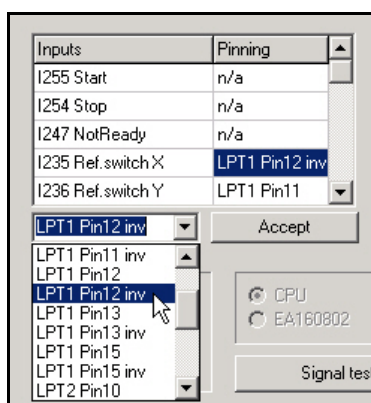

Assignment of pin numbers to the input lines

- With normally open contacts (color change from black to red) always select the normal pin number. With normally closed contacts (color change from red to black) select the inverted pin number, e.g. LPT1 PIN11 Inv.
- After clicking the button *Accept* the selected pin number is displayed in the assignment table.
- Proceed in the same way with all other required input signals.
- Save the parameter settings and if necessary, check once more all assignments with the function *special functions-signal test*. Herewith a pressed switch must always produce a red LED light, i.e. a HIGH level.



With inputs *WinPC-NC* reacts only to a HIGH level. Please take care that the switching logic with the possibility for inverting is assigned in the way that an activated switch generates a HIGH level.

6.3. Assignment of output lines

Assignment of outputs

The assignment of outputs is similar to the assignment of inputs. Please carry out the following steps :

1. Connect the required cables to the available pins and use for control purposes a LED light or a lamp.
2. Click to *Signal test* and observe the LEDs in the next window which are symbolizing the status of the individual output lines

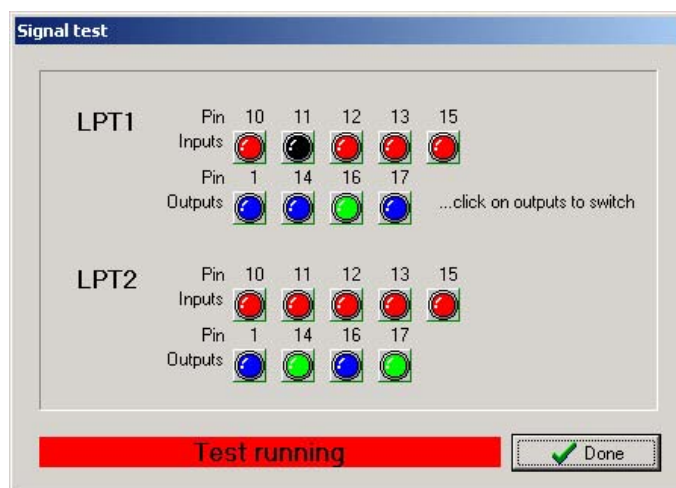

Interactive signal testing

3. Click by mouse on to the possible outputs and observe the level of the cables. A blue LED light signalizes a LOW level or an output switched off. A green LED light signalizes a HIGH level or an output switched on. Please note or notice the corresponding pins as well as the switching logic.
4. Click to the button *Done* and change again into the window of the signal wizzard. Select now the corresponding output signal in the right-hand window (e.g. Q242 spindle on/off) and open the drop-down menu below in order to assign the pin number (e.g. LPT1 PIN1).
5. After clicking the button *Accept* the selected pin number is displayed in the assignment table.

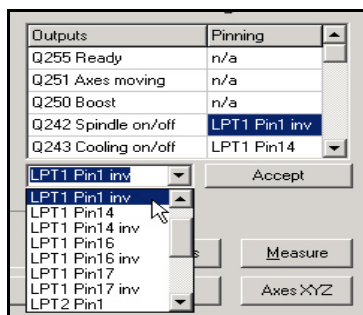

Assignment of the pin number for output lines

6. Proceed in the same way with all other required input signals and finally save the settings.

6.4. Input signals available

Possible inputs

WinPC-NC is able to manage following input signals:

Input signal	Assigned action
I255 Start	Starts loaded job
I254 Stop	Stops immediately each running action with HIGH level, subsequently another reference move has to be carried out
I247 Not ready	Monitors whether the machine is ready and the drives. With HIGH level each running action is immediately stopped.
I235-238 Reference switch	Reference switch of all 4 axes
I239-242 Limit switch -	Limit switch positioned at the negative end of the axis
I243-246 Limit switch +	Limit switch positioned at the positive end of the axis
I234 Zinposition up	Synchronizes a semi-automatic drilling job and with HIGH level it can move to the next position at this input
I233 Zinposition down	Synchronizes a semi-automatic drilling job. The signals Zinposition top and Zinposition down must be activated by turns.
I229-232 Limit switch Summary	Limit switch inputs, if only one switch is appropriate for both ends of the axes, e.g. a flexible switch moving on two cams. Using these inputs, WinPC-NC is not able to recognize the move direction and obviate continuation of the move.
I228 Spindle speed reached	Signal of the milling spindle, when the desired rotation speed has been reached and the job can be continued.
I222 Protection hood	Safety function for protection hoods, light screens and access controls
I221 Length sensor	Input for surface sensors or tool length sensor
I160-169 vacant	Signals freely to dispose, with macro programming.

All additional input signals which are indicated in the table are reserved to special functions or only available in **WinPC-NC Professional**.

6.5. Output signals available

Possible outputs **WinPC-NC is able to manage the following output signals :**

Output signal	Assigned actions
Q255 Ready	Indicates whether the controlling software is ready with HIGH level. In the case of error the output turns to LOW.
Q251 Axis moves	Indicates moving (HIGH) or stopping (LOW) axes. This signal can be used for reducing current at the rating class limits.
Q250 Boost	Indicates ramp moving during the run of axes (HIGH) or displays stopped axes respectively constantly moving axes (LOW). This signal can be used for reducing current at the rating class limits.
Q242 Spindle	Switches on/off the drilling-/milling spindle.
Q243 Cooling	Switches on/off the coolant pump or the spray cooling
Q244 Dispensing	Switches on/off the dispensing signal.
Q245 Purging with compressed air	Indicates with HIGH level an upwards moving and thus a withdrawing Z-axis.
Q246 Job works	Job working in HIGH level and thus indicates automatic operation.
Q249 Spindle lefthand/righthand	Switches the rotation direction of the milling spindle, e.g by M-functions M3 and M4 in G code programs.
Q100-107 Output Mxx	Additional outputs, programmable with M-functions in G code programs.
Q220-230 vacant	Signals freely to dispose, with macro programming.

All additional output signals which are indicated in the table are reserved to special functions or only available in **WinPC-NC Professional**.

7. Additional Information

7.1. Interpreters

At present, interpreters are implemented in *WinPC-NC Economy* for several NC data formats.

- HPGL
- Drilling data
- Multicam
- G code (DIN/ISO)
- ISEL NCP
- Postscript (vector information in EPS and AI files)

7.1.1. HPGL-Interpreter

*Plotter data
with the HPGL
Interpreter*

The HPGL interpreter recognizes the most important commands in HPGL plotter language. Successful tests have been carried out with various CAD and drawing programs.

Drawings from...

- AutoCAD®
- AutoSketch®
- Eagle®
- HCAM®
- CADdy®
- Malz&Kassner CAD®

*Windows HPGL
drivers*

...and other CAD systems can be processed without any problems. Furthermore, the interpreter can also work with HPGL data from the standard Window driver HP-Plotter, which programs such as...

- CorelDRAW®
- Designer®

...and other Windows drawing programs use for preparing their data and storing data in a file. Alternatively, it is also possible to use a driver for following plotters: *HP7475*, *HP Color Pro* or *HP Draftmaster*.

HPGL Syntax

The following commands represent a valid HPGL data file :

PA [x,y[,x,y]];	Move to absolute position(s)
PR [x,y[,x,y]];	Move to relative position(s)
PU [x,y[,x,y]];	Lift and move tool
PD [x,y[,x,y]];	Lower and move tool
SP x;	Select tool
IP x,y[,x,y];	Define scaling points
SC x,y,x,y;	Define scaling factors
CI r[,a];	Draw complete circle
AA x,y,a[,c];	Absolute arc
AR x,y,a[,c];	Relative arc

In addition, the interpreter recognizes the following commands although no response is produced on the machine :

DT ...;	LT ...;
LB ...;	VS ...;
IN ...;	CA ...;

The following non-standard expansions can also be used :

PP ;	Drill hole, lower/lift tool
FCt ;	Wait t milliseconds
FC100,t ;	Wait t milliseconds
FC101,i ;	Wait for HIGH level at input i
FC102,i ;	Wait for LOW level at input i
FC200,a ;	Set output a to HIGH
FC201,a ;	Set output a to LOW

HPGL language prescribes the following syntactical rules, amongst others, which must be observed when creating or revising the data.

- There must always be a pair of coordinates x,y
- All commands with coordinates must have no, one or more coordinate pairs
- Every command must be followed by a semicolon (;) or a new command
- With PA and PR, the subsequent commands are also set to absolute or relative positioning
- The last command should lift the tool (PU;)

HPGL example

PU ;	<i>Start by lifting tool</i>
PA1000,1000 ;	<i>Then move to 1000/1000</i>
SP1 ;	<i>Select tool 1</i>
PD ;	<i>Lower tool</i>
PA1000,2000 ;	<i>Move square</i>
PA2000,2000 ;	
PA2000,1000 ;	
PA1000,1000 ;	
PU ;	<i>Lift tool</i>

7.1.2. MultiCAM-Interpreter

*HPGL
extended with
3D commands*

The MultiCAM format is a 3D expansion of the HPGL standard. It includes all previous HPGL commands and some additional ones by means of which the Z-axis can be moved synchronously with the other axes.

A differentiation is made between 2D and 3D modes. There must always be 3 coordinates in 3D mode, i.e. one for the Z-axis as well.

ZZ0/1;	Activates 2D or 3D mode
ZUz;	Toollift height of the Z-axis over the zero point (overwrites the <i>safety clearance parameter</i>)
ZDz;	Plunge depth (overwrites the depth values in the parameters)
SFv;	Feed rate
ZOd;	Spindle speed

The syntactical rules of HPGL language apply analogously to MultiCAM.

7.1.3. Drilling data interpreter

*Various drilling
data formats*

The drilling data interpreter recognizes data in the following standards Excellon, Sieb&Maier1000 and Sieb&Maier3000.

A drilling file always starts with one or two percent signs and ends with the command M30. In between, there can be any number of lines with X and Y coordinates and the tool number.

*Drilling data
syntax*

The syntax is as follows:

```
% oder %%  
[Xval][Yval][Tx]  
.....  
M30
```

There are two different formats. In format 1, the coordinate values are always 5-digit numbers, although it is possible to leave off the trailing zeros (e.g. X021 corresponds to 2100).

In format 2, leading zeros are discarded and the coordinate values therefore comprise different numbers of digits.

The drilling formats prescribe the following syntactical rules, amongst others, which must be observed when creating or revising the data.

- Every command must be in its own line
- If coordinates and a tool command are contained in the same line, then the tool is changed first before drilling takes place at the position
- The coordinates can also include a decimal point, e.g. X123.456
- All lines before the percent sign(s) are regarded as remarks and are skipped

<i>Sample of drilling data in format 2</i>	Short drilling program in format 2	<i>Remark lines</i>
	%	<i>Start of program</i>
	T1	<i>Select tool 1</i>
	X1000Y1000	<i>Drill hole at 1000/1000</i>
	X1200Y2340	<i>Drill hole at 1200/2340</i>
	X2700Y2950T2	<i>Tool 2 drill hole at 2700/2950</i>
	Y1000	<i>Drill hole at 2700/1000</i>
	M30	<i>End of program</i>

And here is the same example in format 1: (always 5-digit values, with trailing zeros discarded)

<i>Sample of drilling data in format 1</i>	Short drilling program in format 1	<i>Remark lines</i>
	%	<i>Start of program</i>
	T1	<i>Select tool 1</i>
	X01Y01	<i>Drill hole at 1000/1000</i>
	X012Y0234	<i>Drill hole at 1200/2340</i>
	X027Y0295T2	<i>Tool 2 drill hole at 2700/2950</i>
	Y01	<i>Drill hole at 2700/1000</i>
	M30	<i>End of program</i>

7.1.4. G code interpreter

WinPC-NC also contains a small G code command interpreter. The G code language is used in professional and industrial applications for programming NC machines.

The following commands are supported :

G commands	G00	Linear interpolation with rapid speed
	G01	Machining, linear interpolation
	G02	Clockwise circular movement
	G03	Counterclockwise circular movement
	G04	Dwell time, time with F command
	G17	Plane XY
	G18	Plane XZ

	G19	Plane YZ
	G70	Dimensions in inch
	G71	Dimensions in mm
	G90	Absolute position information
	G91	Relative position information
	G98	Define subroutines
M commands	M00	Program halt
	M02	End of program
	M03	Spindle on, clockwise rotation
	M04	Spindle on, counterclockwise rotation
	M05	Spindle off
	M06	Change tool
	M07	Coolant on
	M08	Coolant on
	M09	Coolant off
	M16	Wait for input, input number in F
	M30	End of program
	M66	Change tool, same as M06
	M70	Set output 100 to HIGH
	M71	Set output 101 to HIGH
	M72	Set output 102 to HIGH
	M73	Set output 103 to HIGH
	M74	Set output 104 to HIGH
	M75	Set output 105 to HIGH
	M76	Set output 106 to HIGH
	M77	Set output 107 to HIGH
	M-70	Set output 100 to LOW
	M-71	Set output 101 to LOW
	M-72	Set output 102 to LOW
	M-73	Set output 103 to LOW
	M-74	Set output 104 to LOW
	M-75	Set output 105 to LOW
	M-76	Set output 106 to LOW
	M-77	Set output 107 to LOW
Other	N	Record number
	S	Spindle speed
	F	Pin number (with M16 command)
	F	Dwell time (with G04 command)
	F	Feed (without M16 and G04 command)
		Speed in set unit of measurement (mm/s or mm/min. or inch/min.)
	I,J,K	Circle parameters
	T	Select tool
	X,Y,Z	Coordinates
	U,V,W	Coordinates for 4th axis, if activated
	A,B,C	Coordinates for 4th axis, if activated
	R	Radius of arcs
	L	Call subroutines (1..20)

*Example: Square
with rounded
corners*

```
%prog2
N001 G90
N002 G71 T1 M6
N003 G00 X110 Y100 Z10
N004 G01 Z11
N005 G01 X190
N006 G03 X200 Y110 J10
N007 G01 Y190
N008 G03 X190 Y200 I-10
N009 G01 X110
N010 G03 X100 Y190 J-10
N011 G01 Y110
N012 G03 X110 Y100 I10
N013 G01 Z10
N014 G00 X0 Y0 Z0
N015 M30
```

*Start of program
Absolute coordinates
Dimensions in mm, tool 1
Speed to 1st position
Plunge movement with Z
Feed movement in straight line
Arc about center point
etc...*

*Rapid speed to zero point
End of program*

Bear in mind the following points when writing G code programs :

- The programs must be written using an editor or an external program
- The program name with % sign introduces the real program code, all preceding lines are remark lines
- At least one tool has to be selected and changed, e.g. with T1 M6 in the program head (M6 is absolutely necessary)
- Speeds are adjustable with F commands in mm/sec. or mm/min. defined by parameters.
- The command number can be defined using N commands
- For arcs, you can either use the I, J, K commands to define the center point or R to program a radius. Positive radii produce an arc less than 180° and negative radii an arc greater than 180°.
- Up to 20 subroutines are defined at the end of the main program after M30, using G98 Lx. The definition ends with G98 L0. The subroutine call can be positioned anywhere with Lx.

<i>Example:</i>	%prog2	<i>Start of program</i>
<i>Drilling cycle</i>	N001 G90	<i>Absolute coordinates</i>
<i>as subroutine</i>	N002 G00 X110 Y100	<i>Rapid traverse to 1st position</i>
	N003 L1	<i>Call drilling cycle</i>
	N004 G00 Y110	<i>Next position</i>
	N005 L1	<i>etc...</i>
	N006 G00 Y120	
	N007 L1	
	N008 G00 X0Y0	
	N009 M30	<i>End of program</i>
	N020 G98 L1	<i>Define drilling cycle</i>
	N021 G01 Z20	
	N022 G00 Z0	
	N023 G01 Z25	
	N024 G00 Z0	
	N025 G01 Z30	
	N026 G00 Z0	
	N027 G98 L0	<i>End of subroutine</i>

7.1.5. ISEL NCP interpreter

The format ISEL NCP is common to many users and mainly used by machines and units of the companies ISEL and MES from the Isert group. *WinPC-NC* is able to interpret commands of NCP programs, excepting track data and track sections.

Simple change from ISEL machines With this option it is quite simple to process by *WinPC-NC* current NCP programs with an alternative machine.

Interpreted commands are for example :

FASTVEL	VEL
MOVEABS	FASTABS
MOVEREL	FASTREL
PLANE	CCWABS
CWABS	CCWREL
CWREL	WAIT
GETTOOL	HALT
SPINDLE	COOLANT

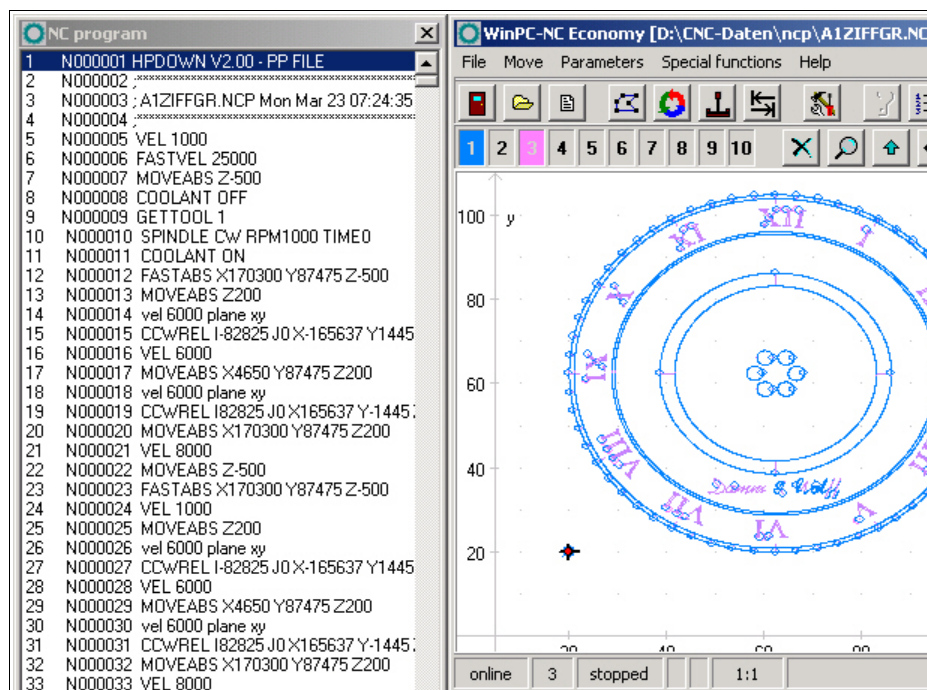

Program and graphical display of an ISEL NCP program

7.1.6. Postscript interpreter

As an additional interpreter a postscript import filter has been implemented in *WinPC-NC* which filters vector information out of common postscript files, e.g. as it is created by Adobe Illustrator® or Corel Draw®. Other postscript informations in the files are uninteresting for CNC processing and are disregarded.

Please create PS files always without header. Unfortunately, a realtime display of the program of postscript files can not be indicated.

7.2. Error messages

Error messages are displayed in a small window in the middle of the screen during operations in *WinPC-NC*. Messages in a gray box do not indicate there is a fault, but only provide information.

The following error messages may occur :

- **Limit switch reached**

The machine has moved on to one of the limit switches. It is necessary to move back from the switch and perform reference rung again before continuing work.

- **Machine not ready**

The connected controller or machine is not ready or not switched on. *WinPC-NC* works in demo modes.

- **HPGL syntax error**

There is an invalid HPGL command in the plotter file. It does not correspond to the syntactical rules and therefore cannot be processed by *WinPC-NC*.
- **Connection canceled**

The connection to the DLL-controller is interrupted. This can happen when other window programs or drives interfere with the realtime tasks.
- **Status stack full/empty**

An internal error has occurred in *WinPC-NC*. Please report this error to the program authors, providing as many details as possible.
- **Incorrect parameter**

A parameter in the WPI or WPW file is incorrect or the parameter file has been corrupted.
- **Stop signal detected**

The stop signal has been detected. Please rectify the fault.
- **Go to reference position first**

WinPC-NC and the controller always need to know what their current position is. Please always perform reference travel after restarting the program.
- **Error xx from controller**

An internal error has occurred in *WinPC-NC* during communication with the realtime module. Please report this error to the program authors, providing as many details as possible.
- **Data cannot be displayed**

The NC data for the current file cannot be displayed graphically. Either they do not match the selected format or they do not contain any tool actions. Another cause for failure may be that the format identification is switched off or that an incorrect data format has been adjusted.
- **Tool not yet defined**

A tool is needed which has not yet been programmed in the tool management system. The appropriate parameters must always be defined prior to using tools.
- **No tool file found**

No tool file can be found. *WinPC-NC* therefore continues to work with default values.
- **Machine is at limit switch**

When both limit switches on an axis are defined, *WinPC-NC* is unable to tell which switch has been reached. Please move the axes in question back from the limit switch manually and then restart reference travel.
- **Service code required**

The axis controller can no longer be controlled and requires a service code before continuing work. Please contact the supplier.
- **Command rejected by controller**

An internal error has occurred in *WinPC-NC* during communication with the realtime module. Please report this error to the program authors, providing as many details as possible.
- **Maschine not ready**

The machine has not been switched on or there is a fault. The *NOT READY* input on the axis controller signals this condition.

- **Communication failed / Timeout**

Communication of *WinPC-NC* interferes with the realtime-DLL. Please report this error to the program authors, providing as many details as possible.
- **Protection hood not closed**

The protective hood or another protective device has not been closed and therefore no process can be started. The machine can still be set up.
- **Command rejected during machine movement**

There is a fault in the connection between *WinPC-NC* and the realtime module. Please report this error to the program authors, providing as many details as possible.
- **File with invalid format**

The selected file does not match the set data format. Change the parameter or the data format to HPGL or drilling format.
- **Help file not found**

The file with the help texts cannot be found. It is called WINPCNC.HLP and must be located in the current folder or in the *WinPC-NC* folder. No help texts can be displayed.
- **Workpiece exceeds working area**

The set working area was exceeded during machining of the current workpiece. It may be possible to rectify this condition by performing reference travel. If not, either change the unit of measurement, move the zero point or increase the working area.
- **Next position outside working area**

The current working process has been cancelled because the next position to which movement should take place is outside the set working area. Correct the settings and restart the working process.
- **Unknown command**

The NC file contains an unknown command and the working process has therefore been stopped. It can now be cancelled or continued with the next command.
- **Cannot create file**

WinPC-NC tried unsuccessfully to create a file on the current drive. Either the drive is not ready or it is full, write protected or you do not have any access rights. Correct the problem or change to another drive.
- **No park position defined**

You can only move to the park position if you have defined the corresponding coordinates, i.e. they are set to values other than zero.
- **Required tools not defined**

The working file uses tool numbers which have not yet been defined. The plunge depth and plunge speed must be defined for every tool, and HPGL files also need the feed speed to be defined.
- **Tool moves in too far**

The plunge depth of a tool or the depth and the defined feed corrections are deeper than the maximum plunge depth or the limit of the Z-axis working area.
- **G code or DIN/ISO syntax error**

There is a syntactical error in the G code file being processed. Please use the editor to correct the line in question and restart the working process.

- **Maschine positioned on the reference switch**

You intend to execute a reference move, however there is at least one axis already positioned on the reference switch. Start moving back all axes from the switches by manual operation.
- **Cannot install file**

WinPC-NC tried unsuccessfully to install a file. Possible causes are insufficient memory capacity or missing allowance for access in the current register.
- **Out of memory**

There is insufficient vacant main memory space for processing actions by *WinPC-NC*. Please extend the virtual memory in the system control and restart *WinPC-NC*.
- **Hardlock error**

There is problem with recognizing the USB-dongle. Please remove the dongle, if necessary, reinstall the drive and insert it into another USB port. Restarting of the drive is made by calling the file SETUPDRV.EXE in the directory of *WinPC-NC*.
- **Incorrect realtime-DLL**

There are communication problems between the actual realtime module and *WinPC-NC* which are probably caused by another licence.

7.3. Special versions of *WinPC-NC*

Special applications on request

The authors are always grateful for opinions and suggestions.

If required, hardware and software solutions can be worked out for your special application, or our standard products can be adapted to optimize their functions for you. Please ask us for a quote without obligation.